

**PUBLIC NOTICE**

**CHARLESTON DISTRICT, CORPS OF ENGINEERS  
69A Hagood Avenue  
Charleston, South Carolina 29403-5107**

REGULATORY DIVISION

Refer to: P/N #SAC-2013-00090-2IG

12 MARCH 2013

Pursuant to Section 10 of the Rivers and Harbors Act of 1899 (33 U.S.C. 403) and the South Carolina Coastal Zone Management Act (48-39-10 et.seq.) an application has been submitted to the Department of the Army and the S.C. Department of Health and Environmental Control by

**KIAWAH RESORT ASSOCIATES, LP  
C/O MR. RAY PANTLIK  
14 NORTH ADGERS WHARF  
CHARLESTON, SOUTH CAROLINA 29401**

for a permit to construct a fixed pier and floating dock in the

**KIAWAH RIVER**

at a location, Lot 78, LeMoyne Lane, in the Cassique neighborhood, Kiawah Island, Charleston County, South Carolina (Latitude 32.5915° - Longitude -80.1334°).

In order to give all interested parties an opportunity to express their views

**NOTICE**

is hereby given that written statements regarding the proposed work will be received by the **Corps** until

**15 Days from the Date of this Notice,**

from those interested in the activity and whose interests may be affected by the proposed work.

The proposed work consists of construction of a 10' x 10' pierhead attached to high land by a 4' 8" x 378.9' walkway. In addition, a 10' x 20' floating dock will be installed on the downstream side of the pierhead and attached to the pierhead by a 3' x 20' ramp. The purpose of the proposed work is for the private recreational use of the future owner of lot 78.

**NOTE: The SCDHEC OCRM has published a separate public notice for the proposed work. In addition, plans depicting the work described in this notice are available and will be provided, upon receipt of a written request, to anyone that is interested in obtaining a copy of the plans for the specific project. The request must identify the project of interest by public notice number and a self-addressed stamped envelope must also be provided for mailing the drawings to you. Your request for drawings should be addressed to the**

**U.S. Army Corps of Engineers  
ATTN: REGULATORY DIVISION  
69A Hagood Avenue  
Charleston, South Carolina 29403-5107**

The work shown on this application must also be certified as consistent with applicable provisions the Coastal Zone Management Program (15 CFR 930). The District Engineer will not process this application to a conclusion until such certifications are received. The applicant is hereby advised that supplemental information may be required by the State to facilitate the review.

This notice initiates the Essential Fish Habitat (EFH) consultation requirements of the Magnuson-Stevens Fishery Conservation and Management Act. Implementation of the proposed project would have minimal impact on estuarine substrates and emergent wetlands utilized by various life stages of species comprising the red drum, shrimp, and snapper-grouper management complexes. Our initial determination is that the proposed action would not have a substantial individual or cumulative adverse impact on EFH or fisheries managed by the South Atlantic Fishery Management Council and the National Marine Fisheries Service (NMFS). Our final determination relative to project impacts and the need for mitigation measures is subject to review by and coordination with the NMFS.

The District Engineer has consulted the most recently available information and has determined that the project will have no effect on any federally endangered, threatened, or proposed species and will not result in the destruction or adverse modification of designated or proposed critical habitat. This public notice serves as a request to the U.S. Fish and Wildlife Service and the National Marine Fisheries Service for any additional information they may have on whether any listed or proposed endangered or threatened species or designated or proposed critical habitat may be present in the area which would be affected by the activity, pursuant to Section 7(c) of the Endangered Species Act of 1973 (as amended).

Pursuant to Section 106 of the National Historic Preservation Act (NHPA), this public notice also constitutes a request to Indian Tribes to notify the District Engineer of any historic properties of religious and cultural significance to them that may be affected by the proposed undertaking.

In accordance with the NHPA, the District Engineer has also consulted the latest published version of the National Register of Historic Places for the presence or absence of registered properties, or properties listed as being eligible for inclusion therein, and this worksite is not included as a registered property or property listed as being eligible for inclusion in the Register. To insure that other cultural resources that the District Engineer is not aware of are not overlooked, this public notice also serves as a request to the State Historic Preservation Office to provide any information it may have with regard to historic and cultural resources.

Any person may request, in writing, within the comment period specified in this notice, that a public hearing be held to consider this application. Requests for a public hearing shall state, with particularity, the reasons for holding a public hearing.

The decision whether to issue a permit will be based on an evaluation of the probable impact including cumulative impacts of the activity on the public interest. That decision will reflect the national concern for both protection and utilization of important resources. The benefit which reasonably may be expected to accrue from the project must be balanced against its reasonably foreseeable detriments. All factors which may be relevant to the project will be considered including the cumulative effects thereof; among those are conservation, economics, aesthetics, general environmental concerns, wetlands, historic properties, fish and wildlife values, flood hazards, flood plain values, land use, navigation, shoreline erosion and accretion, recreation, water supply and conservation, water quality, energy needs, safety, food and fiber production and, in general, the needs and welfare of the people. A permit will be granted unless the District Engineer determines that it would be contrary to the public interest. In cases of conflicting property rights, the Corps of Engineers cannot undertake to adjudicate rival claims.

REGULATORY DIVISION

Refer to: P/N #SAC-2013-00090-2IG

12 MARCH 2013

The Corps of Engineers is soliciting comments from the public; Federal, state, and local agencies and officials; Indian Tribes; and other interested parties in order to consider and evaluate the impacts of this activity. Any comments received will be considered by the Corps of Engineers to determine whether to issue, modify, condition or deny a permit for this project. To make this decision, comments are used to assess impacts on endangered species, historic properties, water quality, general environmental effects, and the other public interest factors listed above. Comments are used in the preparation of an Environmental Assessment and/or an Environmental Impact Statement pursuant to the National Environmental Policy Act. Comments are also used to determine the need for a public hearing and to determine the overall public interest of the activity.

If there are any questions concerning this public notice, please contact Mary Hope Green at 843-329-8044 or toll free at 1-866-329-8187.

Z:\242356\242356.0000\Engineering\Drawings\Permit Drawings\Lot 78 Vicinity and Details.dwg - Jan 15, 2013 - 2:09:26 PM



DATUM: NGVD29

TRACKING NUMBER:			
REVISION HISTORY			
REV. NO.	REVISION	BY	DATE

**VICINITY MAP**

PROPOSED ACTIVITY: *SAC-2013 00090-ZIG*  
 CASSIQUE PH 5 LOT 78 DOCK  
 APPLICANT:  
 KIAWAH RESORT ASSOCIATES, LP  
 LOCATION: CHARLESTON COUNTY, S.C.  
 DATE: December 5, 2012 *Rev 2/11/13* SHEET: 1 OF 8  
 JOB NUMBER: J - 24236 SCALE: NOT TO SCALE

**THOMAS & HUTTON**  
 Engineering | Surveying | Planning | GIS | Consulting  
 682 Johnnie Dodds Blvd. • Suite 100  
 PO Box 1522  
 Mt. Pleasant, SC 29465-1522 • 843.849.0200  
 www.thomasandhutton.com  
 Savannah, GA | Brunswick, GA | Myrtle Beach, SC | Wilmington, NC

Z:\24236\14535.0000\Engineering\Drawings\Permit Drawings\Lot 62-6A\24236.dwg - 62-6A Dwg.dwg - Nov 21, 2012 - 8:42:36 AM

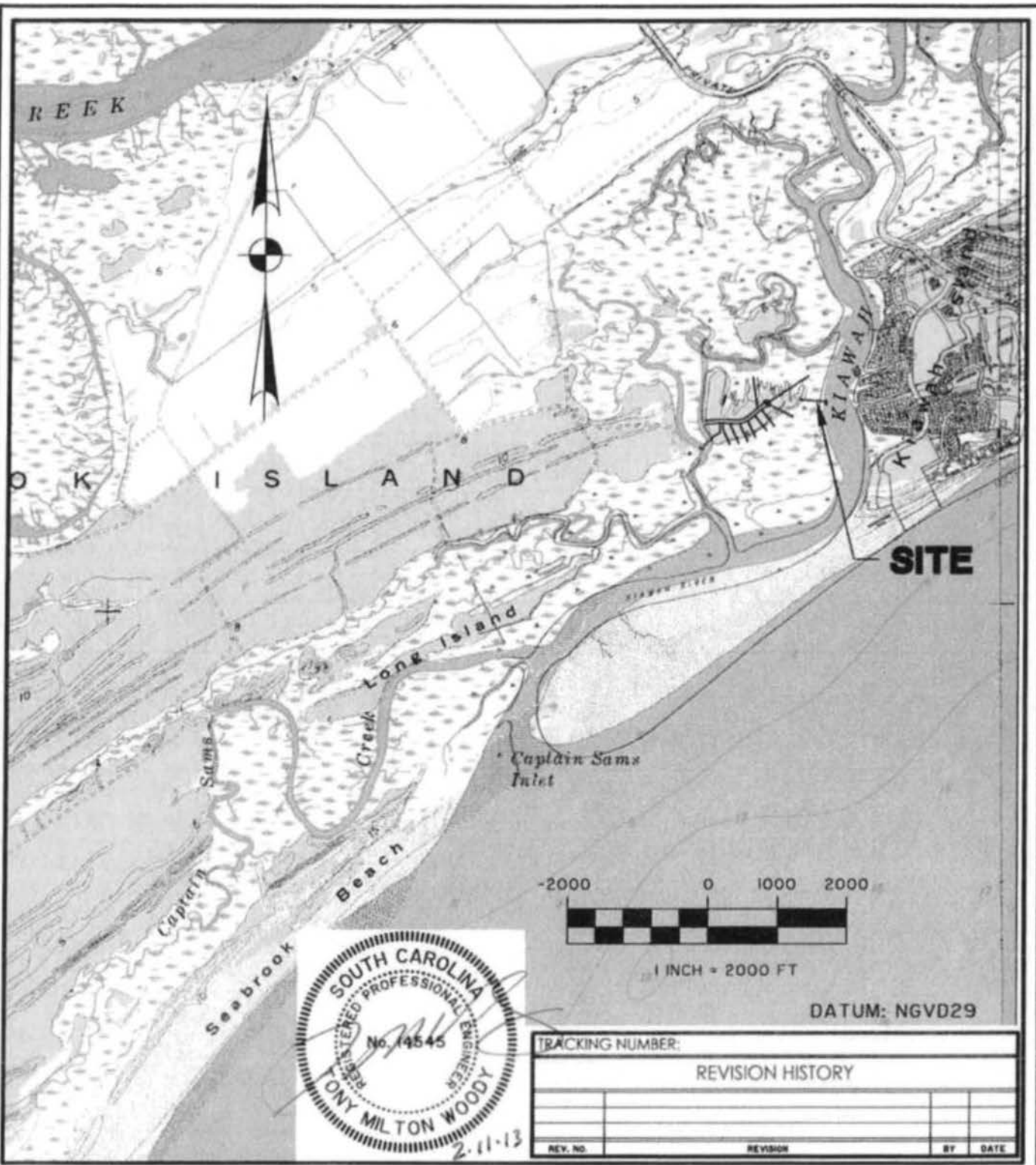

1 INCH = 2000 FT

DATUM: NGVD29



TRACKING NUMBER:			
REVISION HISTORY			
REV. NO.	REVISION	BY	DATE

**LOCATION MAP**  
 LATITUDE: 32.5915° LONGITUDE: 80.1334° SOURCE: ROCKVILLE QUAD  
 CASSIQUE PH 5 LOT 78 DOCK  
 APPLICANT: SAC-2013-00090-2IG  
 KIAWAH RESORT ASSOCIATES, LP  
 LOCATION: CHARLESTON COUNTY, S.C.  
 DATE: December 5, 2012 *Rev 2/11/13* SHEET: 2 OF 8  
 JOB NUMBER: J-24236 SCALE: 1" = 2000'

**THOMAS & HUTTON**  
 Engineering | Surveying | Planning | GIS | Consulting  
 682 Johnnie Dodds Blvd. • Suite 100  
 PO Box 1522  
 Mt. Pleasant, SC 29465-1522 • 843.849.0200  
 www.thomasandhutton.com  
 Savannah, GA | Brunswick, GA | Myrtle Beach, SC | Wilmington, NC



Z:\24236\24236.0000\Engineering\Drawings\Permit Drawings\Lot 78\24236p03 - 78 Site Map.dwg - Jan 15, 2013 - 2:13:11 PM

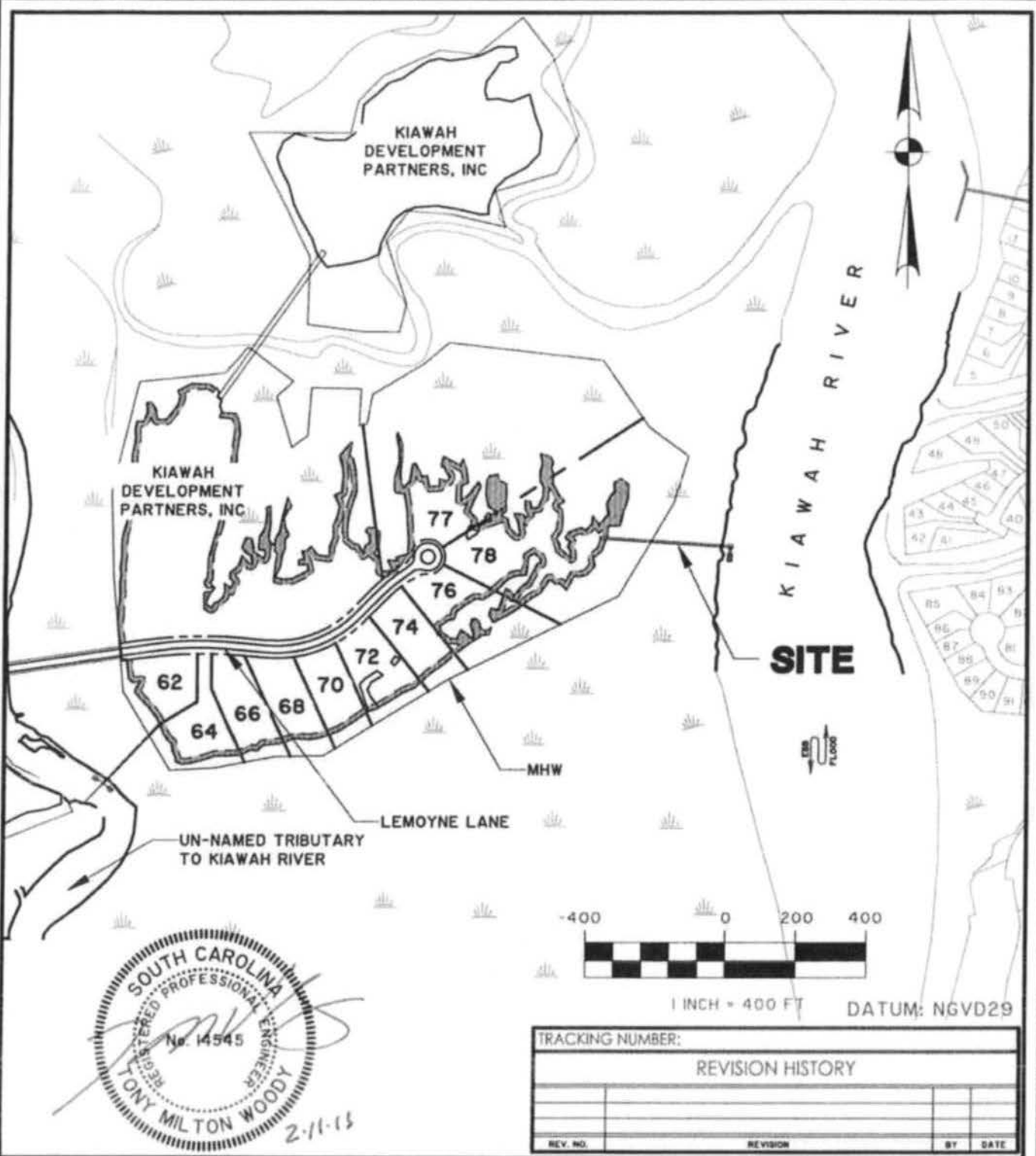

**SITE MAP**

PROPOSED ACTIVITY:  
**CASSIQUE PH 5 LOT 78 DOCK**  
 APPLICANT: *SAC-2013-00090-2IG*  
**KIAWAH RESORT ASSOCIATES, LP**  
 LOCATION: CHARLESTON COUNTY, S.C.  
 DATE: December 5, 2012 *Rev 2/11/13* SHEET: 3 OF 8  
 JOB NUMBER: J - 24236 SCALE: 1" = 400'

TRACKING NUMBER:

REVISION HISTORY

REV. NO.	REVISION	BY	DATE

**THOMAS & HUTTON**  
 Engineering | Surveying | Planning | GIS | Consulting  
 682 Johnnie Dodds Blvd. • Suite 100  
 PO Box 1522  
 Mt. Pleasant, SC 29465-1522 • 843.849.0200  
 www.thomasandhutton.com  
 Savannah, GA | Brunswick, GA | Myrtle Beach, SC | Wilmington, NC

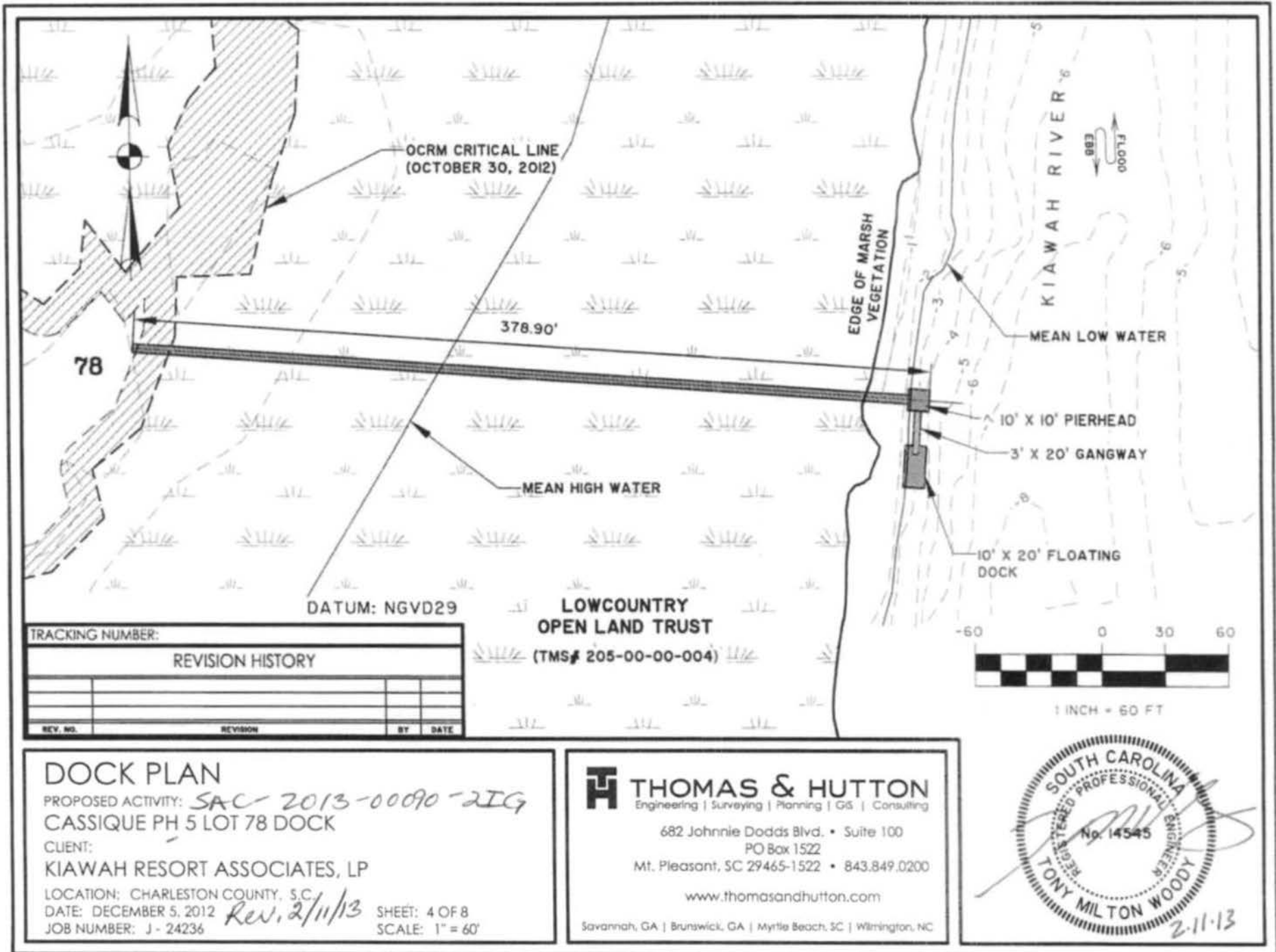

TRACKING NUMBER:

REVISION HISTORY			
REV. NO.	REVISION	BY	DATE

### DOCK PLAN

PROPOSED ACTIVITY: *SAC-2013-00090-2IG*  
 CASSIQUE PH 5 LOT 78 DOCK  
 CLIENT:  
 KIAWAH RESORT ASSOCIATES, LP  
 LOCATION: CHARLESTON COUNTY, S.C.  
 DATE: DECEMBER 5, 2012 *Rev. 2/11/13* SHEET: 4 OF 8  
 JOB NUMBER: J-24236 SCALE: 1" = 60'

### THOMAS & HUTTON

Engineering | Surveying | Planning | GIS | Consulting

682 Johnnie Dodds Blvd. • Suite 100  
 PO Box 1522  
 Mt. Pleasant, SC 29465-1522 • 843.849.0200

www.thomasandhutton.com

Savannah, GA | Brunswick, GA | Myrtle Beach, SC | Wilmington, NC



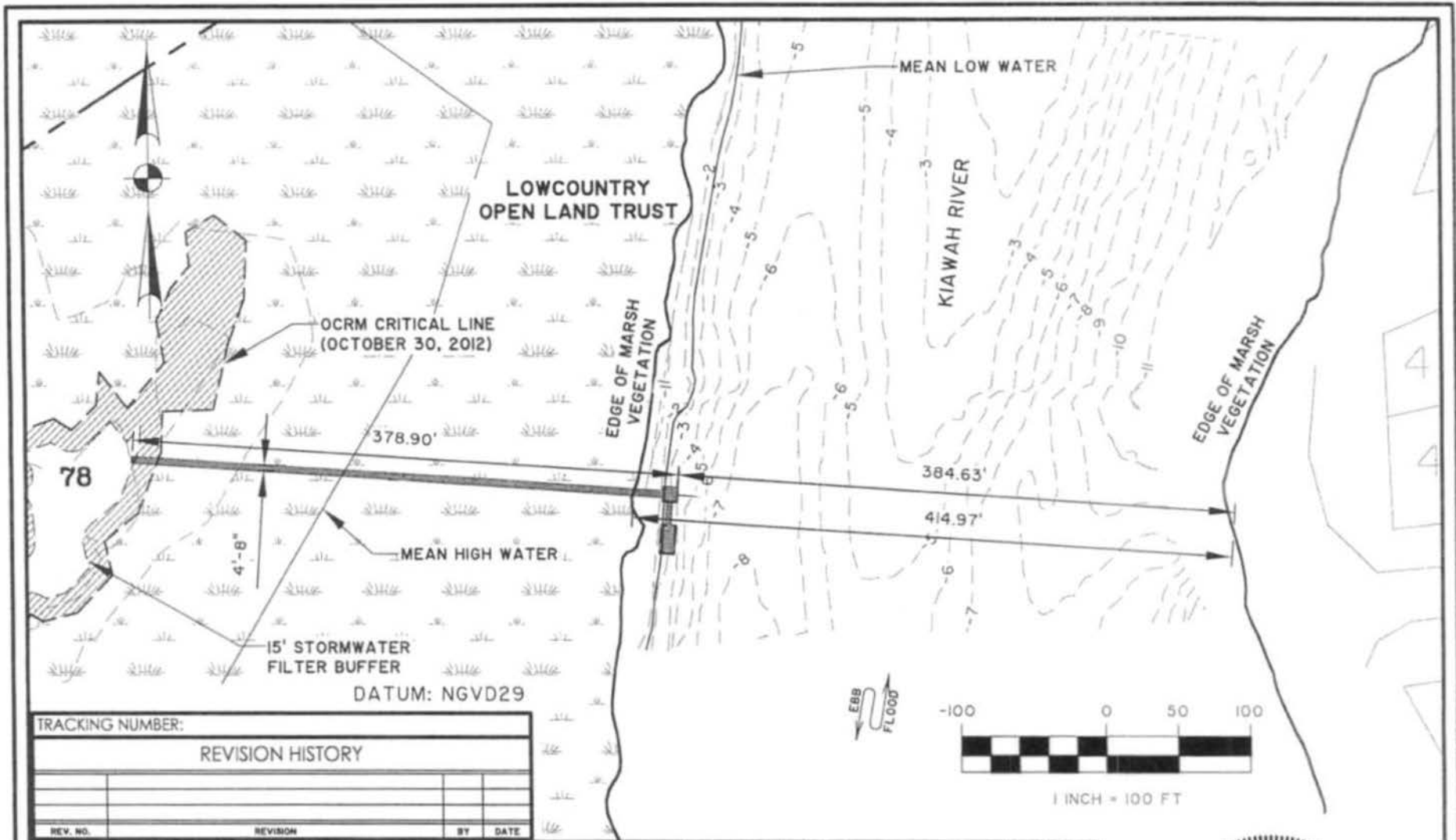

TRACKING NUMBER:

REVISION HISTORY

REV. NO.	REVISION	BY	DATE

**DOCK PLAN**  
 PROPOSED ACTIVITY: SAC-2013-00090-2IG  
 CASSIQUE PH 5 LOT 78 DOCK  
 CLIENT:  
 KIAWAH RESORT ASSOCIATES, LP  
 LOCATION: CHARLESTON COUNTY, S.C.  
 DATE: DECEMBER 5, 2012  
 JOB NUMBER: J-24236

Rev 2/11/13

SHEET: 5 OF 8  
 SCALE: 1" = 100'

**THOMAS & HUTTON**  
 Engineering | Surveying | Planning | GIS | Consulting

682 Johnnie Dodds Blvd. • Suite 100  
 PO Box 1522  
 Mt. Pleasant, SC 29465-1522 • 843.849.0200

www.thomasandhutton.com

Savannah, GA | Brunswick, GA | Myrtle Beach, SC | Wilmington, NC





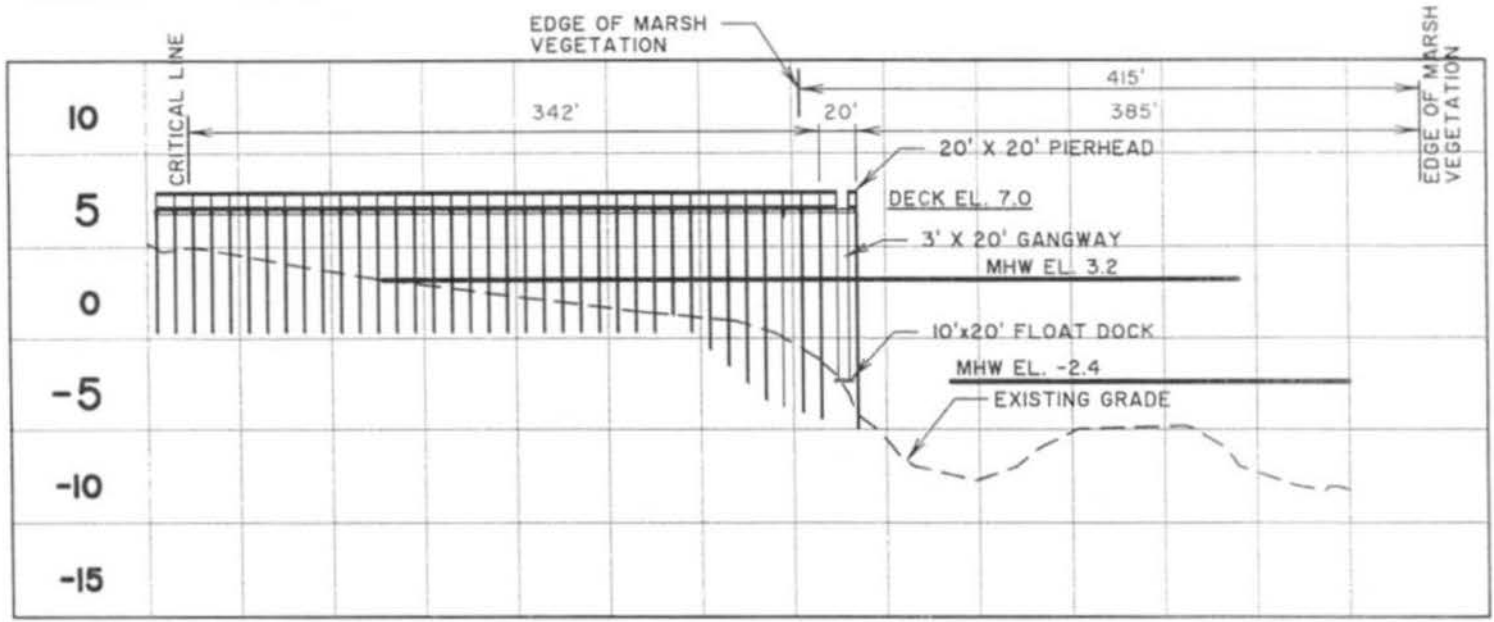

DATUM: NGVD29

**DOCK LOT 78**  
 SCALE: HORZ.: 1" = 100'  
 VERT.: 1" = 10'

TRACKING NUMBER:			
REVISION HISTORY			
REV. NO.	REVISION	BY	DATE

**DOCK PROFILE**

PROPOSED ACTIVITY: *SAC-2013-00090-RIG*  
 CASSIQUE PH 5 LOT 78 DOCK  
 CLIENT:  
 KIAWAH RESORT ASSOCIATES, LP  
 LOCATION: CHARLESTON COUNTY, S.C.  
 DATE: DECEMBER 5, 2012 *REV 2/11/13* SHEET: 6 OF 8  
 JOB NUMBER: J-24236 SCALE: 1" = 100'

**THOMAS & HUTTON**  
 Engineering | Surveying | Planning | GIS | Consulting  
 682 Johnnie Dodds Blvd. • Suite 100  
 PO Box 1522  
 Mt. Pleasant, SC 29465-1522 • 843.849.0200  
 www.thomasandhutton.com  
 Savannah, GA | Brunswick, GA | Myrtle Beach, SC | Wilmington, NC



Z:\24236\24236.0000\Engineering\Drawings\Permit Drawings\Let 78\24236p0 - 78 Vicinity and Details.dwg - Jan. 15, 2013 - 2:09:26 PM

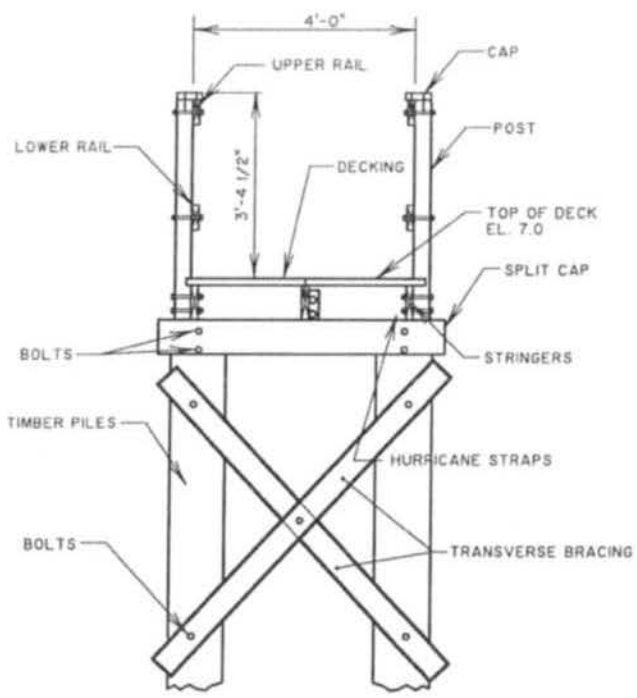

DATUM: NGVD29

TRACKING NUMBER:			
REVISION HISTORY			
REV. NO.	REVISION	BY	DATE

**PIER SECTION**

PROPOSED ACTIVITY: SAC-2013-00090-2IG  
 CASSIQUE PH 5 LOT 78 DOCK  
 APPLICANT:  
 KIAWAH RESORT ASSOCIATES, LP  
 LOCATION: CHARLESTON COUNTY, S.C.  
 DATE: December 5, 2012  
 JOB NUMBER: J- 24236  
 SHEET: 7 OF 8  
 SCALE: NOT TO SCALE  
*Rev. 2/11/13*

**THOMAS & HUTTON**  
 Engineering | Surveying | Planning | GIS | Consulting  
 682 Johnnie Dodds Blvd. • Suite 100  
 PO Box 1522  
 Mt. Pleasant, SC 29465-1522 • 843.849.0200  
 www.thomasandhutton.com  
 Savannah, GA | Brunswick, GA | Myrtle Beach, SC | Wilmington, NC

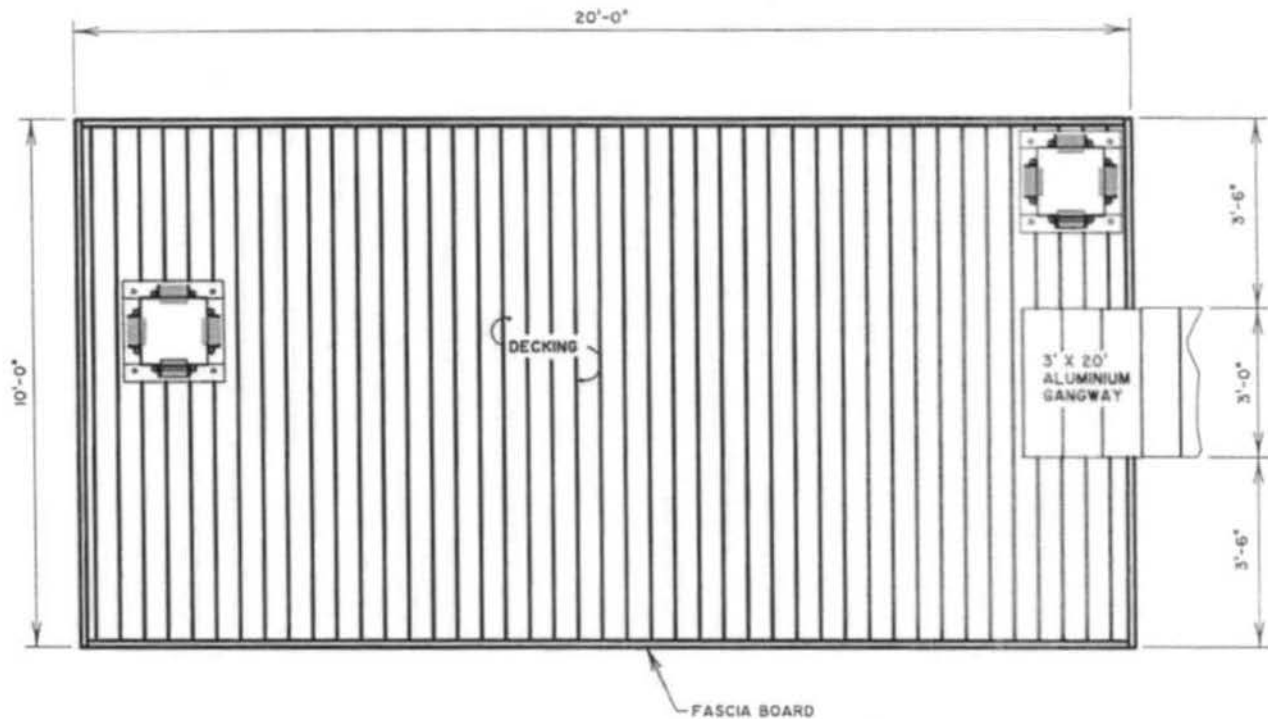

~~TYPICAL OF FLOATING DOCKS~~

DATUM: NGVD29

TRACKING NUMBER:			
REVISION HISTORY			
REV. NO.	REVISION	BY	DATE

### FLOAT PLAN

PROPOSED ACTIVITY: SAC-2013-00090-2IG  
 CASSIQUE PH 5 LOT 78 DOCK  
 APPLICANT:  
 KIAWAH RESORT ASSOCIATES, LP  
 LOCATION: CHARLESTON COUNTY, S.C.  
 DATE: December 5, 2012  
 JOB NUMBER: J - 24236

Rev 2/11/13

SHEET: 8 OF 8  
 SCALE: NOT TO SCALE

**THOMAS & HUTTON**  
 Engineering | Surveying | Planning | GIS | Consulting

682 Johnnie Dodds Blvd. • Suite 100  
 PO Box 1522  
 Mt. Pleasant, SC 29465-1522 • 843.849.0200

www.thomasandhutton.com

Savannah, GA | Brunswick, GA | Myrtle Beach, SC | Wilmington, NC

