

JOINT
PUBLIC NOTICE

CHARLESTON DISTRICT, CORPS OF ENGINEERS
69A Hagood Avenue
Charleston, South Carolina 29403-5107
and
THE S.C. DEPARTMENT OF HEALTH AND ENVIRONMENTAL CONTROL
Water Quality Certification and Wetlands Section
2600 Bull Street
Columbia, South Carolina 29201

REGULATORY DIVISION
Refer to: SAC-2021-00518

February 27, 2023

Pursuant to Sections 401 and 404 of the Clean Water Act (33 U.S.C. 1344) and the South Carolina Coastal Zone Management Act (48-39-10 et.seq.), an application has been submitted to the Department of the Army and the S.C. Department of Health and Environmental Control by

Mr. Jeff Sicheloff
South Carolina Department of Transportation
955 Park Street
Columbia, South Carolina 29201
and
Mr. Marcus Sizemore
Stantec Consulting Services
4969 Centre Pointe Drive Suite 200
North Charleston, South Carolina 29418

for a permit to construct safety improvements for SC 165 in freshwater wetlands associated with

Fishburne Creek

located along SC 165 for approximately 10 miles in length starting at the intersection of Clubhouse Road and SC 165, continuing to the northeast ending near the Ashley Ridge High School in Ravenel, Dorchester County, South Carolina (Latitude: 32.8825 °, Longitude: -80.2664 °), Clubhouse Crossroads quadrangle.

In order to give all interested parties an opportunity to express their views

NOTICE

is hereby given that written statements regarding the proposed work will be received by the **Corps** until

15 Days from the Date of this Notice,

and **SCDHEC** will receive written statements regarding the proposed work until

30 Days from the Date of this Notice

from those interested in the activity and whose interests may be affected by the proposed work.

NOTE: This public notice and associated plans are available on the Corps' website at: <http://www.sac.usace.army.mil/Missions/Regulatory/PublicNotices> .

Applicant's Stated Purpose

According to the applicant, the purpose of the proposed project is to reduce the frequency and severity of crashes along the SC 165 corridor while maximizing traffic operations.

Project Description

The proposed work consists of impacts to waters of the United States for safety improvements to the existing SC 165 roadway and associated right of way. In detail, the proposed work would include discharging fill material into a total of 2.21 acres of freshwater wetlands and excavating a total of 0.65 acre of freshwater wetlands.

Avoidance and Minimization

The applicant has stated that the proposed project will avoid and/or minimize impacts to the aquatic environment by "staying within the existing right-of-way. Guardrail and 2:1 slopes are being constructed where necessary to stay within the right-of-way and minimize fill encroachments. The preferred shoulder width for new construction on this classification of roadway is 10 feet, but the existing right-of-way is being improved from the existing 4 feet to 6 feet to minimize wetland impacts. On the right side and from 162+00 to 169+50, the slope has been increased from 4:1 to 3:1 to minimize wetland impacts."

Proposed Compensatory Mitigation

The applicant has proposed to mitigate for impacts to wetlands and/or waters of the United States by purchasing 28.28 wetland mitigation credits from a Corps approved mitigation bank.

South Carolina Department of Health and Environmental Control

The District Engineer has concluded that the discharges associated with this project, both direct and indirect, should be reviewed by the certifying authority, South

Carolina Department of Health and Environmental Control, in accordance with provisions of Section 401 of the Clean Water Act (CWA). The CWA Section 401 Certification Rule (Certification Rule, 40 CFR 121), effective September 11, 2020, requires certification, or waiver, for any license or permit that authorizes an activity that may result in a discharge. The scope of a CWA Section 401 Certification is limited to assuring that a discharge from a Federally licensed or permitted activity will comply with water quality requirements. The applicant is responsible for requesting certification and providing required information to the certifying authority. In accordance with Certification Rule part 121.12, the Corps will notify the U.S. Environmental Protection Agency Administrator when it has received a Department of the Army (DA) permit application and the related certification. The Administrator is responsible for determining if the discharge may affect water quality in a neighboring jurisdiction. The DA permit may not be issued pending the conclusion of the Administrator's determination of effects on neighboring jurisdictions.

The work shown on this application must also be certified as consistent with applicable provisions of the Coastal Zone Management Program (15 CFR 930). This activity may also require evaluation for compliance with the S. C. Construction in Navigable Waters Permit Program. State review, permitting and certification is conducted by the S. C. Department of Health and Environmental Control. The District Engineer will not process this application to a conclusion until such certifications are received. The applicant is hereby advised that supplemental information may be required by the State to facilitate the review.

Essential Fish Habitat

This notice initiates the Essential Fish Habitat (EFH) consultation requirements of the Magnuson-Stevens Fishery Conservation and Management Act. Implementation of the proposed project would not impact estuarine substrates and emergent wetlands utilized by various life stages of species comprising the shrimp, and snapper-grouper management complexes. The District Engineer's initial determination is that the proposed action would not have a substantial individual or cumulative adverse impact on EFH or fisheries managed by the South Atlantic Fishery Management Council and the National Marine Fisheries Service (NMFS). The District Engineer's final determination relative to project impacts and the need for mitigation measures is subject to review by and coordination with the NMFS.

Endangered Species

Pursuant to the Section 7 of the Endangered Species Act of 1973 (as amended), the Corps has reviewed the project and based on the location of the project and available information, the following species may be present in the County(s) where the work will occur: American wood stork (*Mycteria americana*), Northern long-eared bat (*Myotis septentrionalis*), red-cockaded woodpecker (*Picoides borealis*), Atlantic sturgeon (*Acipenser oxyrinchus*), and shortnose sturgeon (*Acipenser brevirostrum*).

Based on all information provided by the applicant and the most recently available

information, the District Engineer has determined the following:

The project will have no effect on red-cockaded woodpecker (*Picoides borealis*), Atlantic sturgeon (*Acipenser oxyrinchus*), and shortnose sturgeon (*Acipenser brevirostrum*) and will not result in the destruction or adverse modification of designated or proposed critical habitat.

The project is not likely to adversely affect American wood stork (*Mycteria americana*) and Northern long-eared bat (*Myotis septentrionalis*) or result in the destruction or adverse modification of designated or proposed critical habitat. This public notice serves as a request for written concurrence from the U.S. Fish and Wildlife Service and/or the National Marine Fisheries Service on this determination.

This public notice serves as a request to the U.S. Fish and Wildlife Service and the National Marine Fisheries Service for any additional information they may have on whether any listed or proposed endangered or threatened species or designated or proposed critical habitat may be present in the area which would be affected by the activity.

Cultural Resources

Pursuant to Section 106 of the National Historic Preservation Act (NHPA), this public notice also constitutes a request to Indian Tribes to notify the District Engineer of any historic properties of religious and cultural significance to them that may be affected by the proposed undertaking.

In accordance with Section 106 of the NHPA, the District Engineer has consulted South Carolina ArchSite (GIS), for the presence or absence of historic properties (as defined in 36 C.F.R. 800.16)(1)(1)), and has initially determined that there are historic properties present, but they will not be affected; therefore, there will be no effect on historic properties. To ensure that other historic properties that the District Engineer is not aware of are not overlooked, this public notice also serves as a request to the State Historic Preservation Office and other interested parties to provide any information they may have with regard to historic properties. This public notice serves as a request for concurrence within 30 days from the SHPO (and/or Tribal Historic Preservation Officer).

The District Engineer's final eligibility and effect determination will be based upon coordination with the SHPO and/or THPO, as appropriate and required and with full consideration given to the proposed undertaking's potential direct and indirect effects on historic properties within the Corps-identified permit area.

Corps' Evaluation

The decision whether to issue a permit will be based on an evaluation of the probable impact including cumulative impacts of the proposed activity on the public interest and will include application of the guidelines promulgated by the Administrator, Environmental Protection Agency (EPA), under authority of Section 404(b) of the Clean

Water Act and, as appropriate, the criteria established under authority of Section 102 of the Marine Protection, Research and Sanctuaries Act of 1972, as amended. That decision will reflect the national concern for both protection and utilization of important resources. The benefit which reasonably may be expected to accrue from the project must be balanced against its reasonably foreseeable detriments. All factors which may be relevant to the project will be considered including the cumulative effects thereof; among those are conservation, economics, aesthetics, general environmental concerns, wetlands, historic properties, fish and wildlife values, flood hazards, flood plain values, land use, navigation, shoreline erosion and accretion, recreation, water supply and conservation, water quality, energy needs, safety, food and fiber production and, in general, the needs and welfare of the people. A permit will be granted unless the District Engineer determines that it would be contrary to the public interest. In cases of conflicting property rights, the Corps cannot undertake to adjudicate rival claims.

Solicitation of Public Comment

The Corps is soliciting comments from the public; Federal, state, and local agencies and officials; Indian Tribes; and other interested parties in order to consider and evaluate the impacts of this activity. Any comments received will be considered by the Corps to determine whether to issue, modify, condition or deny a permit for this project. To make this decision, comments are used to assess impacts on endangered species, historic properties, water quality, general environmental effects, and the other public interest factors listed above. Comments are used in the preparation of an Environmental Assessment and/or an Environmental Impact Statement pursuant to the National Environmental Policy Act. Comments are also used to determine the need for a public hearing and to determine the overall public interest of the activity. Any person may request, in writing, within the comment period specified in this notice, that a public hearing be held to consider this application. Requests for a public hearing shall state, with particularity, the reasons for holding a public hearing.

Please submit comments in writing, identifying the project of interest by public notice/file number (SAC-2021-00518), to Jeremy.M.Kinney@usace.army.mil or the following address:

**U.S. Army Corps of Engineers
ATTN: REGULATORY DIVISION
69A Hagood Avenue
Charleston, South Carolina 29403-5107**

If there are any questions concerning this public notice, please contact Jeremy M. Kinney, Project Manager, at (843) 714-4649, toll free at 1-866-329-8187, or by email at Jeremy.M.Kinney@usace.army.mil.

COUNTY	ROUTE NO.	ROUTE NAME	SHEET NO.
DORCHESTER	SC 165	DELMAR HIGHWAY	1

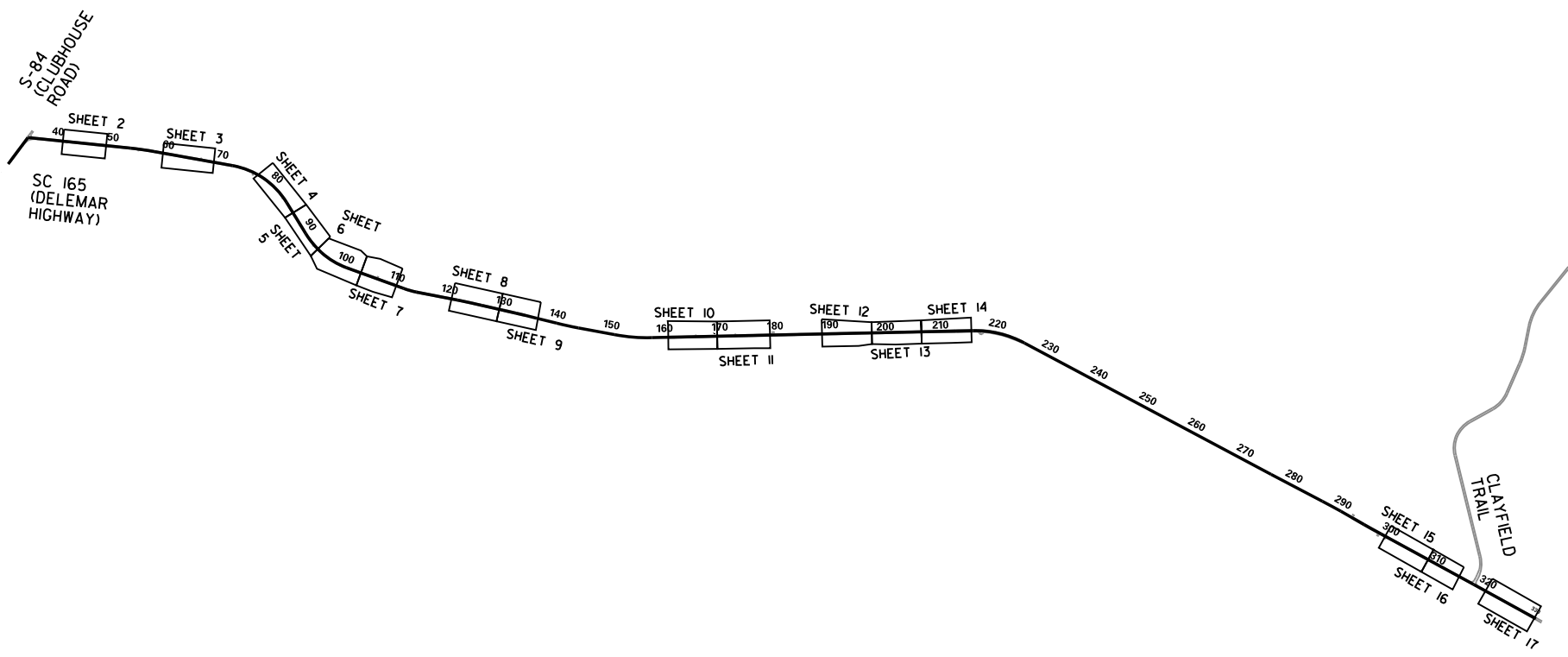
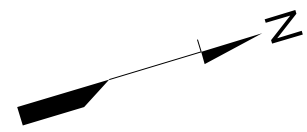

PLANS NOT FOR CONSTRUCTION

TOTAL IMPACTS	
WETLAND PERMANENT FILL IMPACT	2.61 AC (6,084 CY)
WETLAND PERMANENT EXCAVATION	0.78 AC (1,717 CY)

PREPARED BY:

 Stantec Consulting Services
 4969 Centre Pointe Drive, Suite 200
 North Charleston, SC 29418
 Tel: 843.740.7700
 Fax: 843.740.7707
 www.stantec.com

REV. NO.	BY	DATE	DESCRIPTION OF REVISION
4			
3			
2			
1			

STANTEC PROJECT NUMBER: 171002316
 DATE: 5/17/2022
 SCDOT PIN: _____

SCALE IN FEET

APPLICATION BY: **SCDOT**
 SOUTH CAROLINA DEPARTMENT OF TRANSPORTATION
 DORCHESTER COUNTY
 PROJECT ID P038365
 SC 165 (DELMAR HIGHWAY)
 404 PERMIT DRAWINGS
 SCALE: 1" = 3000' SHEET 1 OF 35

COUNTY	ROUTE NO.	ROUTE NAME	SHEET NO.
DORCHESTER	SC 165	DELMAR HIGHWAY	2

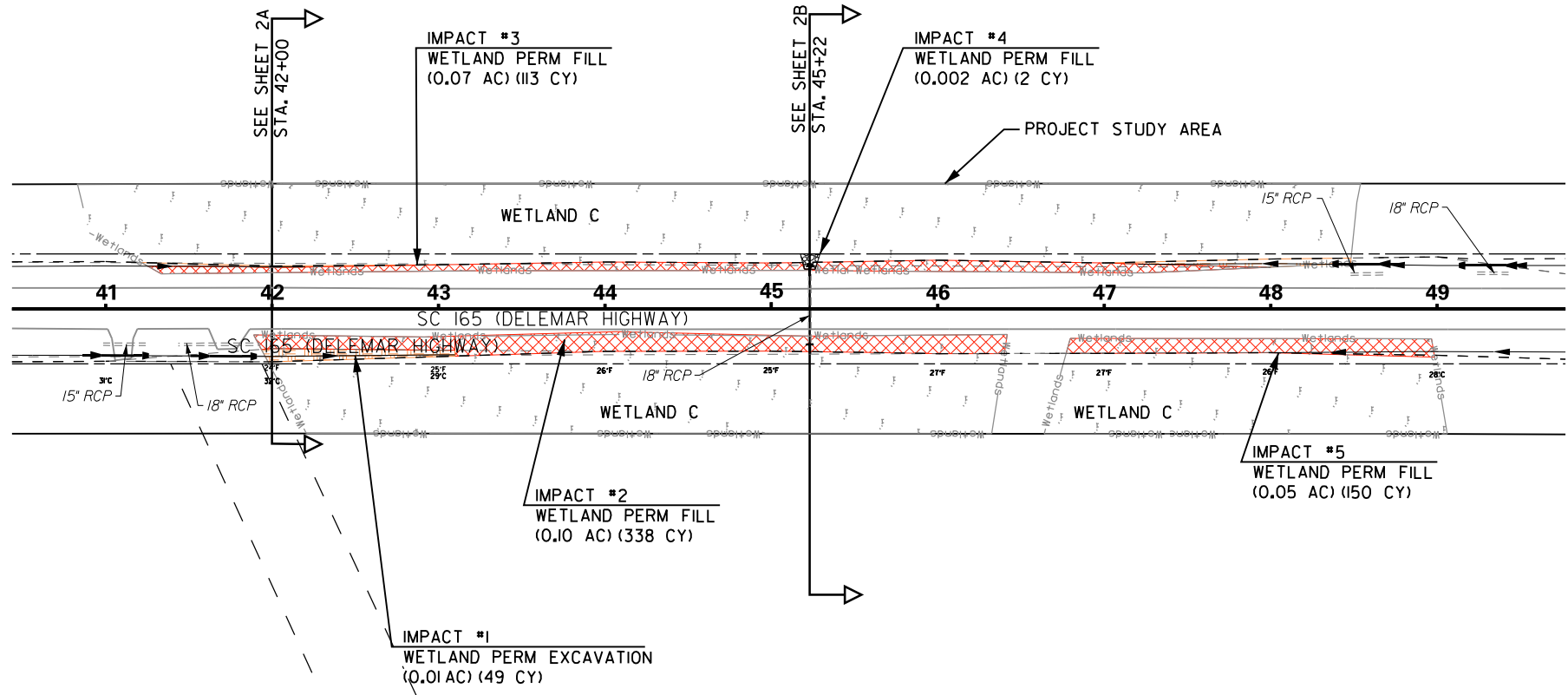
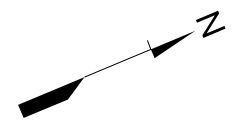

LEGEND	
FILL/CUT LIMIT	---
OPEN WATER	
WETLAND	
RPW STREAM	
PERMANENT WETLAND EXCAVATION IMPACT	
PERMANENT WETLAND FILL IMPACT	

PREPARED BY:
Stantec
 Stantec Consulting Services
 4969 Centre Pointe Drive, Suite 200
 North Charleston, SC 29418
 Tel: 843.740.7700
 Fax: 843.740.7707
 www.stantec.com

REV. NO.	BY	DATE	DESCRIPTION OF REVISION
4			
3			
2			
1			

STANTEC PROJECT NUMBER: 171002316
 DATE: 5/17/2022
 SCDOT PIN: _____

SCALE IN FEET

PLANS NOT FOR CONSTRUCTION

APPLICATION BY: **SCDOT**
 SOUTH CAROLINA DEPARTMENT OF TRANSPORTATION

DORCHESTER COUNTY
 SC 165 (DELMAR HIGHWAY)
 IMPACT PLAN VIEW
 404 PERMIT DRAWINGS

SCALE: 1" = 100'
 SHEET 2 OF 35

COUNTY	ROUTE NO.	ROUTE NAME	SHEET NO.
DORCHESTER	SC 165	DELMAR HIGHWAY	2A

SC 165 (DELMAR HIGHWAY) STA. 42+00.00

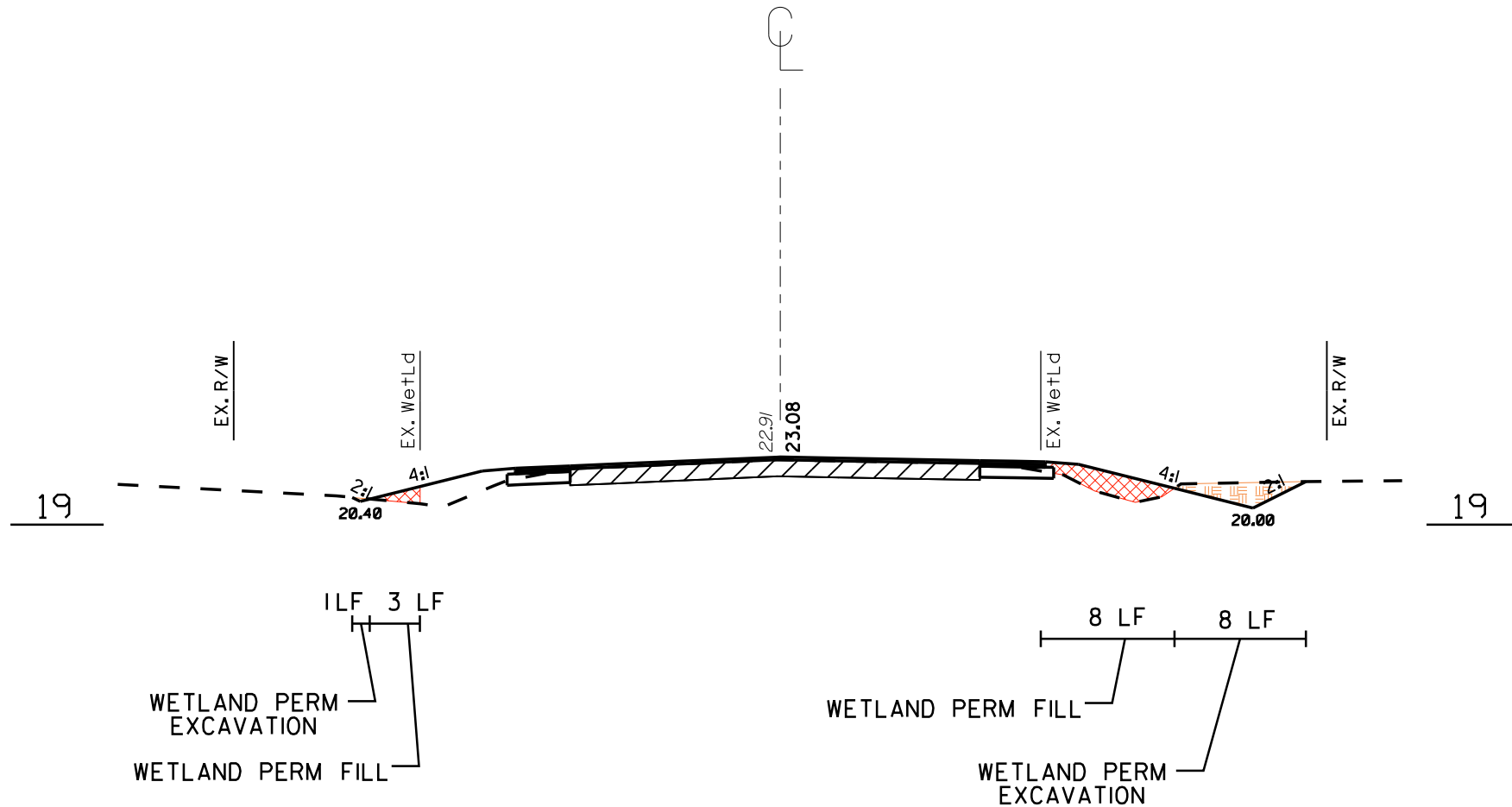

WETLAND PERMANENT FILL IMPACT



WETLAND PERMANENT EXCAVATION IMPACT

PREPARED BY:



Stantec Consulting Services
4969 Centre Pointe Drive, Suite 200
North Charleston, SC 29418
Tel: 843.740.7700
Fax: 843.740.7707
www.stantec.com

4			
3			
2			
1			
REV. NO.	BY	DATE	DESCRIPTION OF REVISION
STANTEC PROJECT NUMBER: 171002316			
DATE: 05/17/2022			
SCDOT PIN: _____			

APPLICATION BY: **SCDOT**
SOUTH CAROLINA DEPARTMENT OF TRANSPORTATION

DORCHESTER COUNTY
SC 165 (DELMAR HIGHWAY)
PROJECT ID P038365
404 PERMIT DRAWINGS

SCALE: N.T.S. SHEET 3 OF 35

COUNTY	ROUTE NO.	ROUTE NAME	SHEET NO.
DORCHESTER	SC 165	DELMAR HIGHWAY	2B

SC 165 (DELMAR HIGHWAY)

STA. 45+23.16

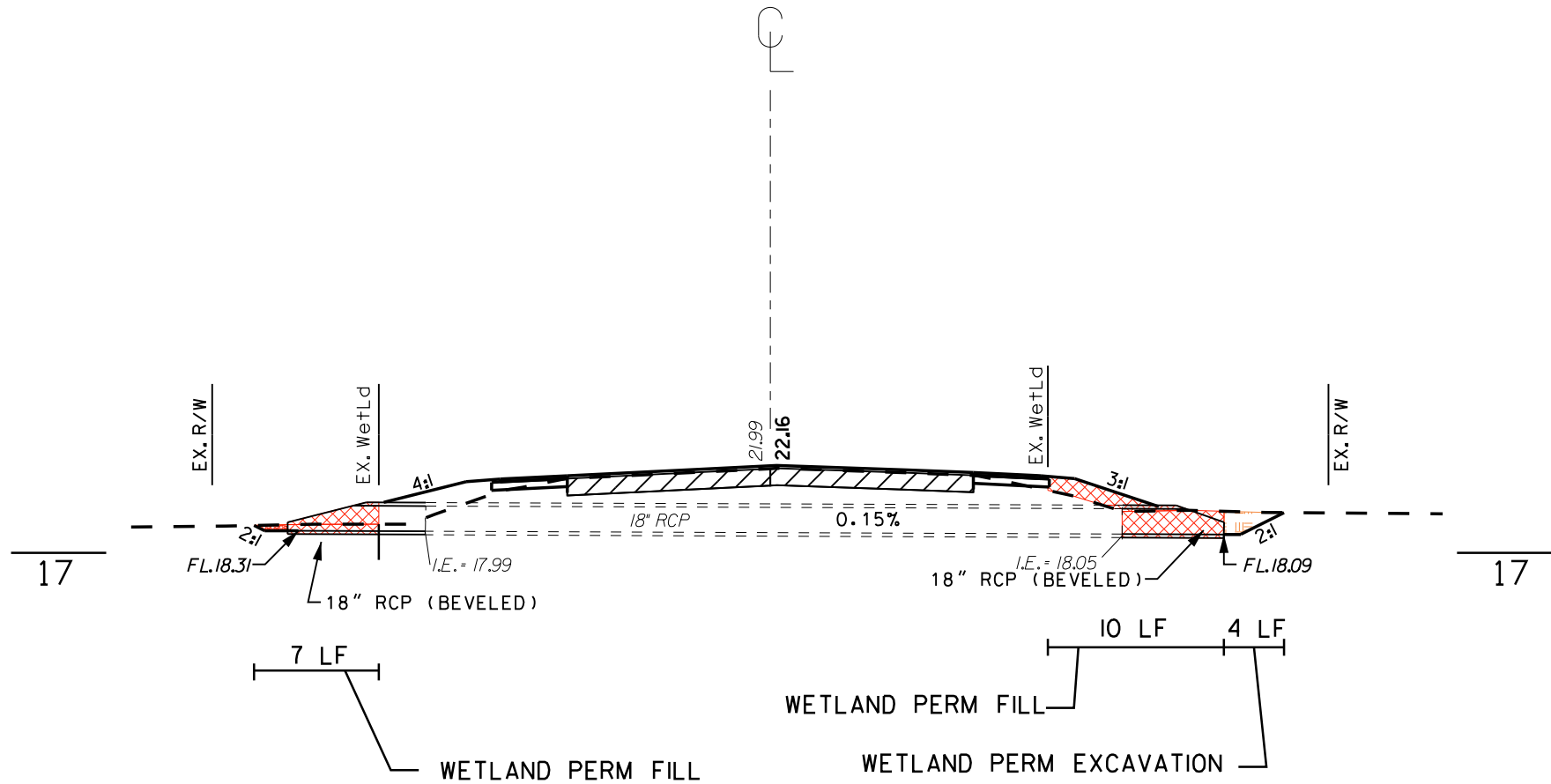

WETLAND PERMANENT FILL IMPACT



WETLAND PERMANENT EXCAVATION IMPACT

PREPARED BY:



Stantec Consulting Services
 4969 Centre Pointe Drive, Suite 200
 North Charleston, SC 29418
 Tel: 843.740.7700
 Fax: 843.740.7707
 www.stantec.com

4			
3			
2			
1			
REV. NO.	BY	DATE	DESCRIPTION OF REVISION
STANTEC PROJECT NUMBER: 171002316			
DATE: 05/17/2022			
SCDOT PIN: _____			

APPLICATION BY: **SCDOT**
 SOUTH CAROLINA DEPARTMENT OF TRANSPORTATION

DORCHESTER COUNTY
 SC 165 (DELMAR HIGHWAY)
 PROJECT ID P038365
 404 PERMIT DRAWINGS

SCALE: N.T.S. SHEET 4 OF 35

COUNTY	ROUTE NO.	ROUTE NAME	SHEET NO.
DORCHESTER	SC 165	DELMAR HIGHWAY	3

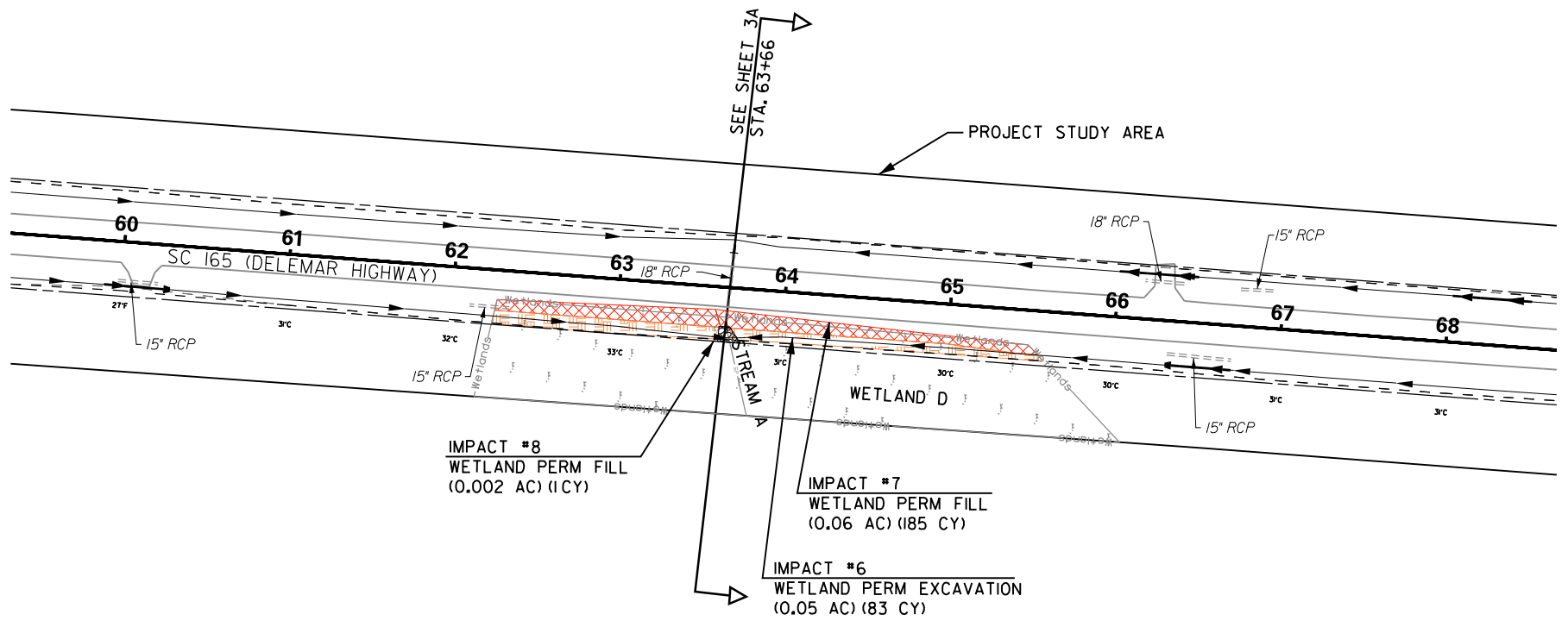
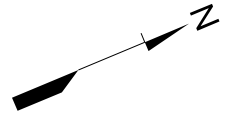

IMPACT #8
WETLAND PERM FILL
(0.002 AC) (1 CY)

IMPACT #7
WETLAND PERM FILL
(0.06 AC) (85 CY)

IMPACT #6
WETLAND PERM EXCAVATION
(0.05 AC) (83 CY)

LEGEND

FILL/CUT LIMIT	----
OPEN WATER	
WETLAND	
RPW STREAM	
PERMANENT WETLAND EXCAVATION IMPACT	
PERMANENT WETLAND FILL IMPACT	

PREPARED BY:
Stantec
Stantec Consulting Services
4969 Centre Pointe Drive, Suite 200
North Charleston, SC 29418
Tel: 843.740.7700
Fax: 843.740.7707
www.stantec.com

REV. NO.	BY	DATE	DESCRIPTION OF REVISION
4			
3			
2			
1			
STANTEC PROJECT NUMBER: 171002316			
DATE: 5/17/2022			
SCDOT PIN: _____			

PLANS NOT FOR CONSTRUCTION

APPLICATION BY: **SCDOT**
SOUTH CAROLINA DEPARTMENT OF TRANSPORTATION

DORCHESTER COUNTY
SC 165 (DELMAR HIGHWAY)
IMPACT PLAN VIEW
404 PERMIT DRAWINGS

SCALE: 1" = 100' SHEET 5 OF 35

COUNTY	ROUTE NO.	ROUTE NAME	SHEET NO.
DORCHESTER	SC 165	DELMAR HIGHWAY	3A

SC 165 (DELMAR HIGHWAY) STA. 63+66.61

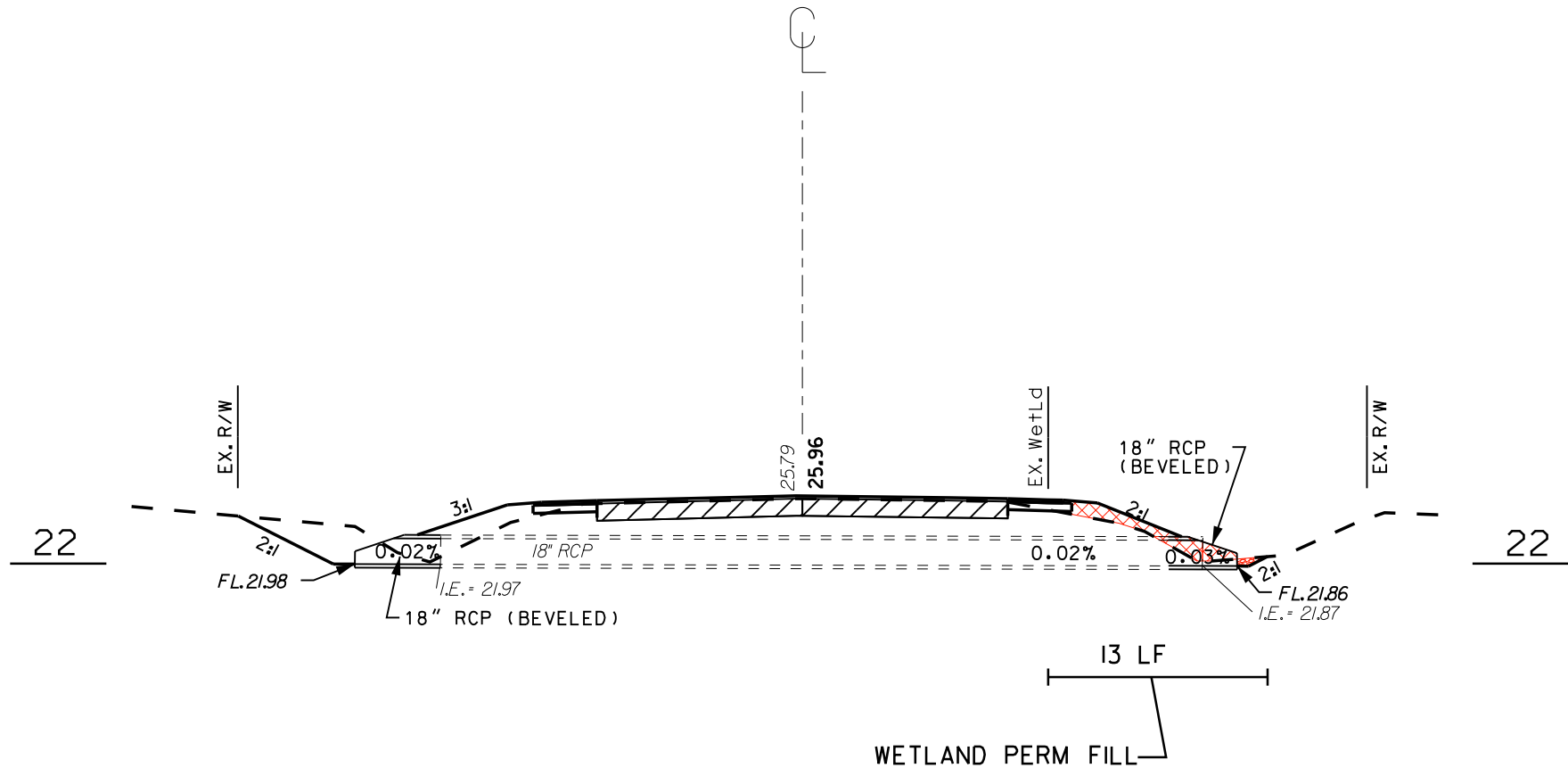

WETLAND PERMANENT FILL IMPACT



WETLAND PERMANENT EXCAVATION IMPACT

PREPARED BY:



Stantec Consulting Services
4969 Centre Pointe Drive, Suite 200
North Charleston, SC 29418
Tel: 843.740.7700
Fax: 843.740.7707
www.stantec.com

4			
3			
2			
1			
REV. NO.	BY	DATE	DESCRIPTION OF REVISION
STANTEC PROJECT NUMBER: 171002316			
DATE: 05/17/2022			
SCDOT PIN: _____			

APPLICATION BY: **SCDOT**
SOUTH CAROLINA DEPARTMENT OF TRANSPORTATION
DORCHESTER COUNTY
SC 165 (DELMAR HIGHWAY)
PROJECT ID P038365
404 PERMIT DRAWINGS
SCALE: N.T.S. SHEET 6 OF 35

COUNTY	ROUTE NO.	ROUTE NAME	SHEET NO.
DORCHESTER	SC 165	DELMAR HIGHWAY	4

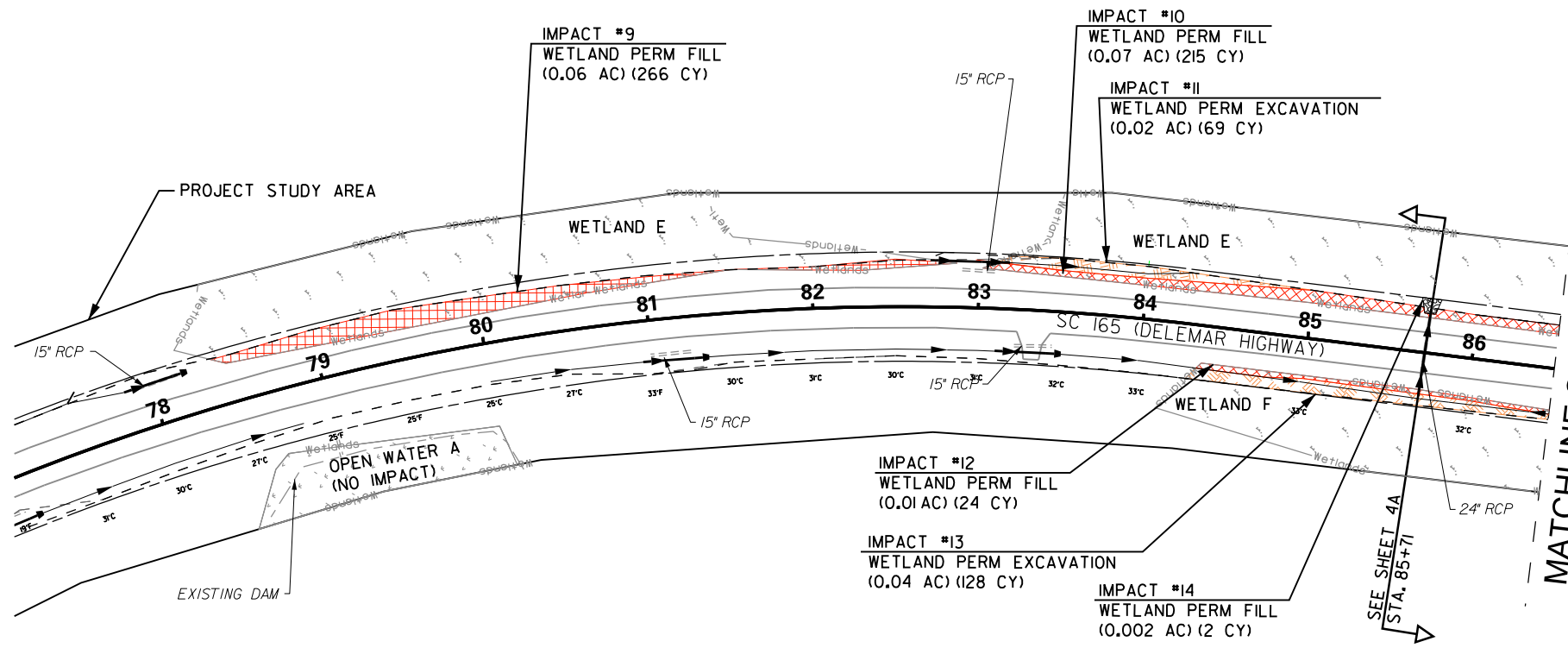

MATCHLINE STA. 86+50 SEE SHEET 5

SEE SHEET 4A
STA. 85+71

LEGEND

FILL/CUT LIMIT	---
OPEN WATER	
WETLAND	
RPW STREAM	
PERMANENT WETLAND EXCAVATION IMPACT	
PERMANENT WETLAND FILL IMPACT	

PREPARED BY:
Stantec
 Stantec Consulting Services
 4969 Centre Pointe Drive, Suite 200
 North Charleston, SC 29418
 Tel: 843.740.7700
 Fax: 843.740.7707
 www.stantec.com

REV. NO.	BY	DATE	DESCRIPTION OF REVISION
4			
3			
2			
1			
STANTEC PROJECT NUMBER: 171002316		SCALE IN FEET	
DATE: 5/17/2022			
SCDOT PIN:			

PLANS NOT FOR CONSTRUCTION

APPLICATION BY: **SCDOT**
 SOUTH CAROLINA DEPARTMENT OF TRANSPORTATION

DORCHESTER COUNTY
 SC 165 (DELMAR HIGHWAY)
 IMPACT PLAN VIEW
 404 PERMIT DRAWINGS

SCALE: 1" = 100'

SHEET 7 OF 35

COUNTY	ROUTE NO.	ROUTE NAME	SHEET NO.
DORCHESTER	SC 165	DELMAR HIGHWAY	4A

SC 165 (DELMAR HIGHWAY) STA. 85+71.17

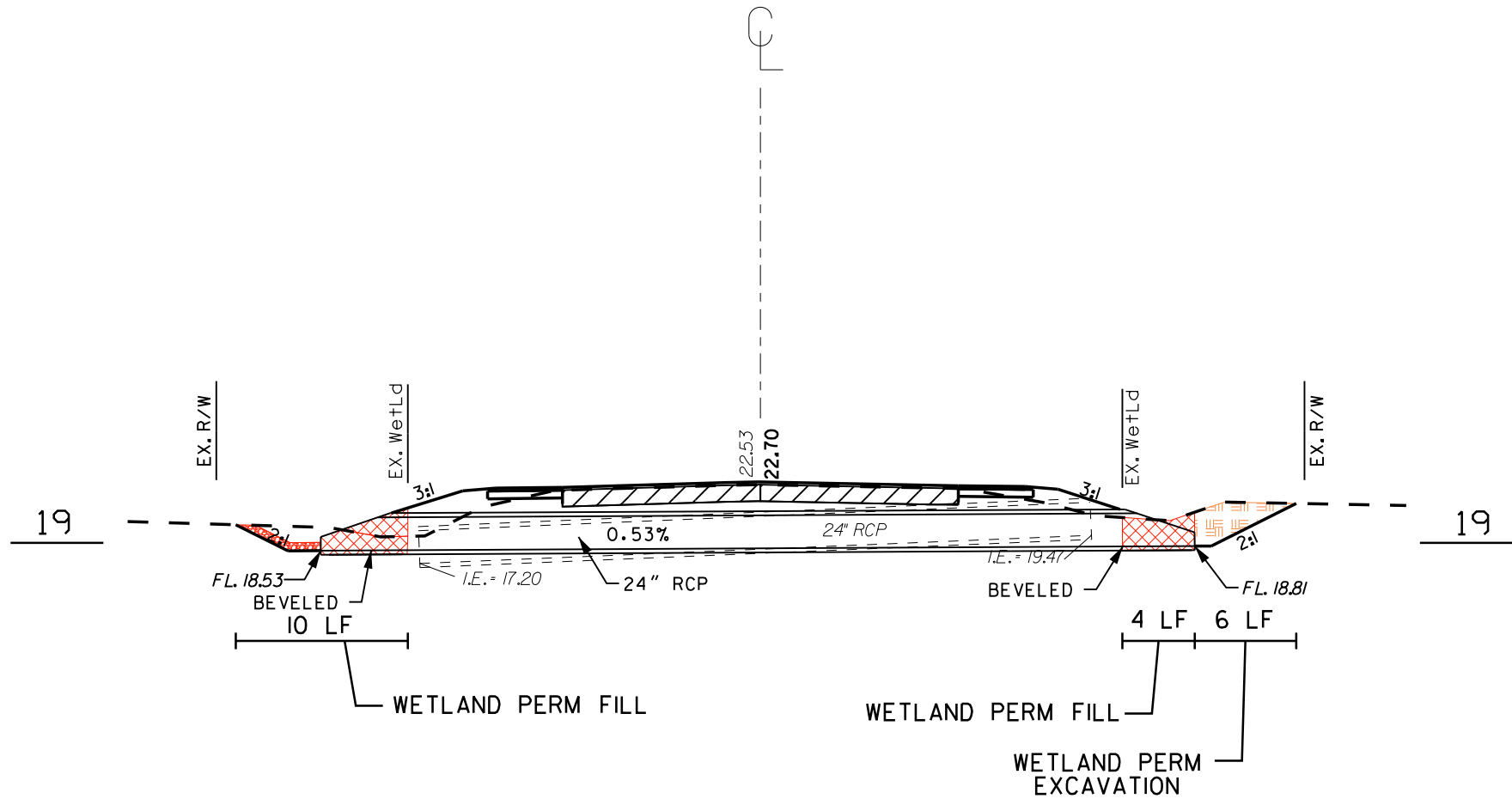

WETLAND PERMANENT FILL IMPACT



WETLAND PERMANENT EXCAVATION IMPACT

PREPARED BY:



Stantec Consulting Services
4969 Centre Pointe Drive, Suite 200
North Charleston, SC 29418
Tel: 843.740.7700
Fax: 843.740.7707
www.stantec.com

4			
3			
2			
1			
REV. NO.	BY	DATE	DESCRIPTION OF REVISION
STANTEC PROJECT NUMBER: 171002316			
DATE: 05/17/2022			
SCDOT PIN: _____			

APPLICATION BY: **SCDOT**
SOUTH CAROLINA DEPARTMENT OF TRANSPORTATION

DORCHESTER COUNTY
SC 165 (DELMAR HIGHWAY)
PROJECT ID P038365
404 PERMIT DRAWINGS

SCALE: N.T.S. SHEET 8 OF 35

COUNTY	ROUTE NO.	ROUTE NAME	SHEET NO.
DORCHESTER	SC 165	DELMAR HIGHWAY	5



MATCHLINE STA. 86+50 SEE SHEET 4

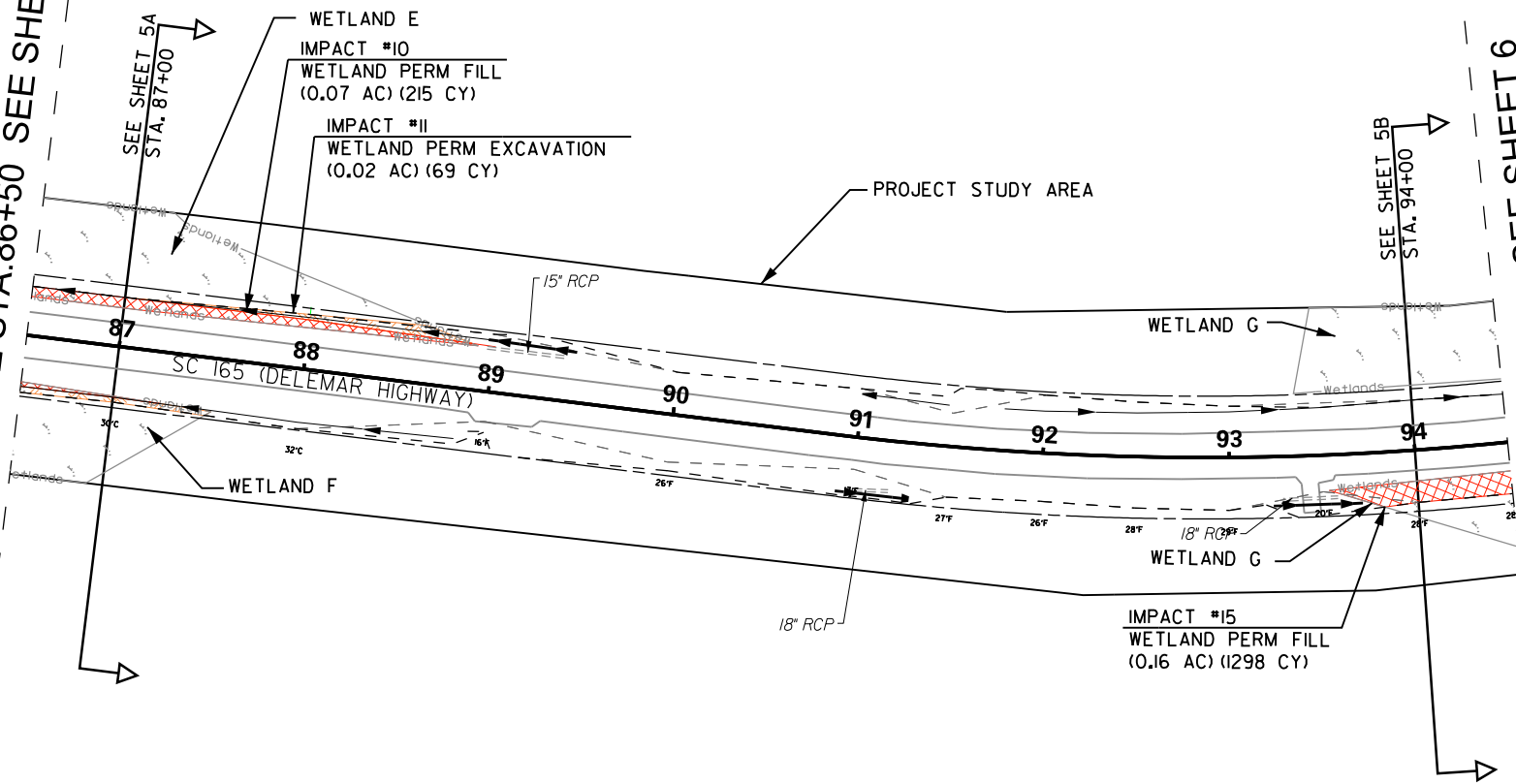

MATCHLINE STA. 94+50 SEE SHEET 6

LEGEND

FILL/CUT LIMIT	----
OPEN WATER	
WETLAND	
RPW STREAM	SP
PERMANENT WETLAND EXCAVATION IMPACT	
PERMANENT WETLAND FILL IMPACT	

PREPARED BY:
Stantec
Stantec Consulting Services
4969 Centre Pointe Drive, Suite 200
North Charleston, SC 29418
Tel: 843.740.7700
Fax: 843.740.7707
www.stantec.com

REV. NO.	BY	DATE	DESCRIPTION OF REVISION
4			
3			
2			
1			
STANTEC PROJECT NUMBER: 171002316		SCALE IN FEET	
DATE: 5/17/2022			
SCDOT PIN:			

PLANS NOT FOR CONSTRUCTION

APPLICATION BY: **SCDOT**
SOUTH CAROLINA DEPARTMENT OF TRANSPORTATION

DORCHESTER COUNTY
SC 165 (DELMAR HIGHWAY)
IMPACT PLAN VIEW
404 PERMIT DRAWINGS

SCALE: 1" = 100'

SHEET 9 OF 35

COUNTY	ROUTE NO.	ROUTE NAME	SHEET NO.
DORCHESTER	SC 165	DELMAR HIGHWAY	5A

SC 165 (DELMAR HIGHWAY) STA. 87+00.00

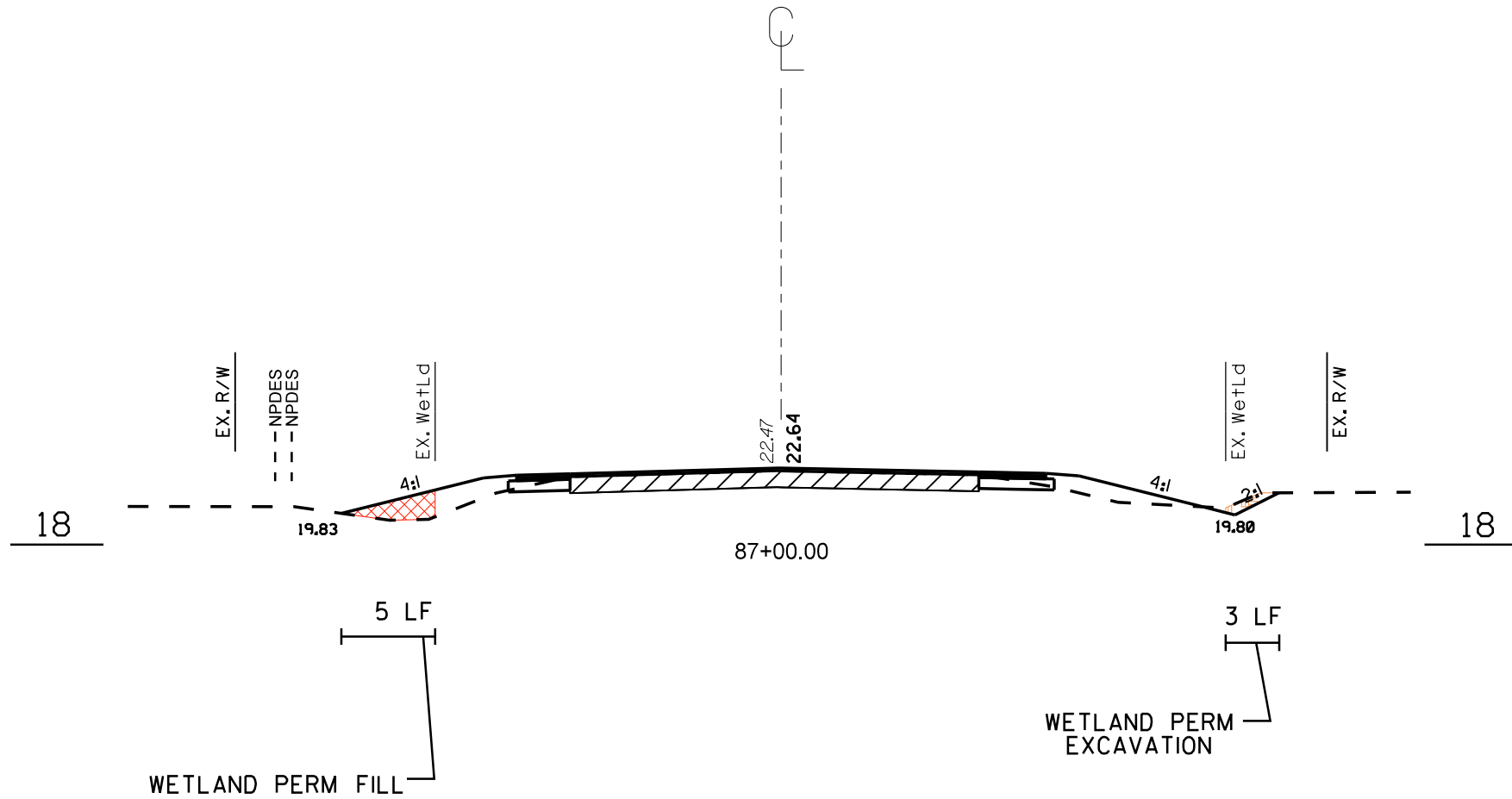

WETLAND PERMANENT FILL IMPACT



WETLAND PERMANENT EXCAVATION IMPACT

PREPARED BY:



Stantec Consulting Services
4969 Centre Pointe Drive, Suite 200
North Charleston, SC 29418
Tel: 843.740.7700
Fax: 843.740.7707
www.stantec.com

4			
3			
2			
1			
REV. NO.	BY	DATE	DESCRIPTION OF REVISION
STANTEC PROJECT NUMBER: 171002316			
DATE: 05/17/2022			
SCDOT PIN: _____			

APPLICATION BY:	SCDOT
SOUTH CAROLINA DEPARTMENT OF TRANSPORTATION	
DORCHESTER COUNTY	
SC 165 (DELMAR HIGHWAY)	
PROJECT ID P038365	
404 PERMIT DRAWINGS	
SCALE:	N.T.S.
SHEET 10 OF 35	

COUNTY	ROUTE NO.	ROUTE NAME	SHEET NO.
DORCHESTER	SC 165	DELMAR HIGHWAY	5B

SC 165 (DELMAR HIGHWAY) STA. 94+00.00

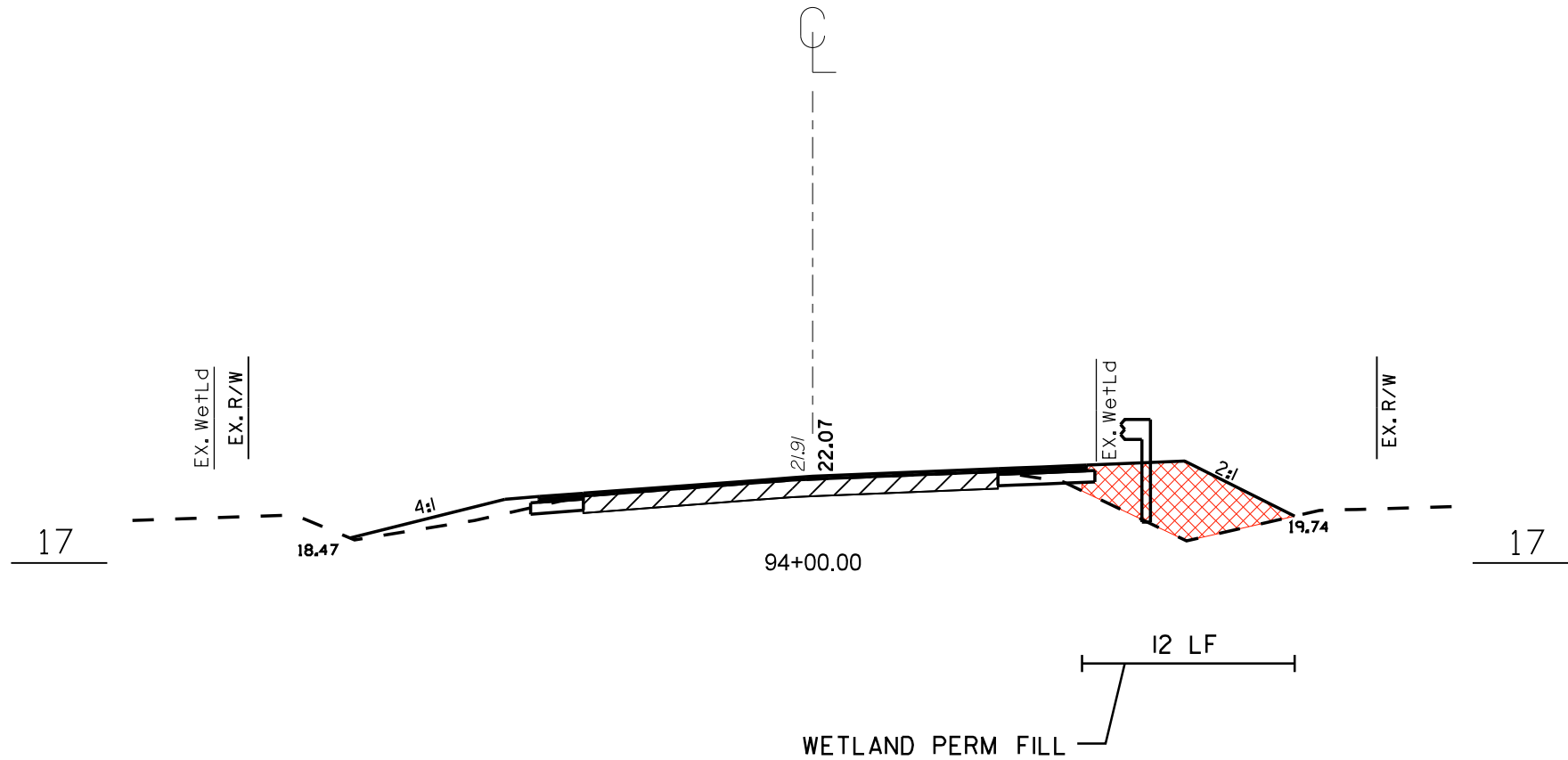

WETLAND PERMANENT FILL IMPACT



WETLAND PERMANENT EXCAVATION IMPACT

PREPARED BY:



Stantec Consulting Services
4969 Centre Pointe Drive, Suite 200
North Charleston, SC 29418
Tel: 843.740.7700
Fax: 843.740.7707
www.stantec.com

4			
3			
2			
1			
REV. NO.	BY	DATE	DESCRIPTION OF REVISION
STANTEC PROJECT NUMBER: 171002316			
DATE: 05/17/2022			
SCDOT PIN: _____			

APPLICATION BY: **SCDOT**
SOUTH CAROLINA DEPARTMENT OF TRANSPORTATION

DORCHESTER COUNTY
SC 165 (DELMAR HIGHWAY)
PROJECT ID P038365
404 PERMIT DRAWINGS

SCALE: N.T.S. SHEET 11 OF 35

COUNTY	ROUTE NO.	ROUTE NAME	SHEET NO.
DORCHESTER	SC 165	DELMAR HIGHWAY	6

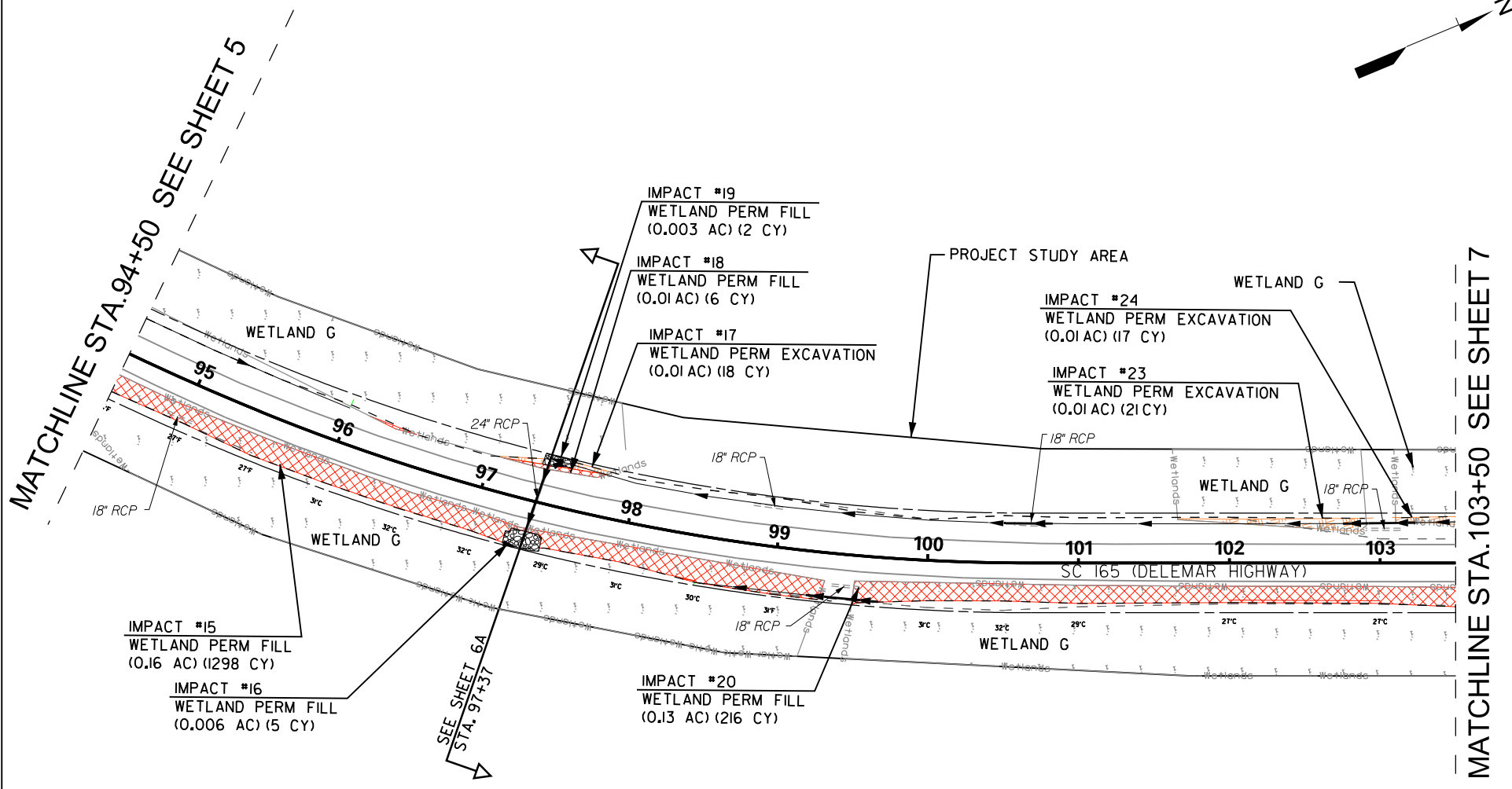
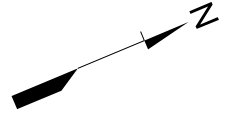

LEGEND	
FILL/CUT LIMIT	---
OPEN WATER	
WETLAND	
RPW STREAM	
PERMANENT WETLAND EXCAVATION IMPACT	
PERMANENT WETLAND FILL IMPACT	

PREPARED BY:
Stantec
 Stantec Consulting Services
 4969 Centre Pointe Drive, Suite 200
 North Charleston, SC 29418
 Tel: 843.740.7700
 Fax: 843.740.7707
 www.stantec.com

REV. NO.	BY	DATE	DESCRIPTION OF REVISION
4			
3			
2			
1			

STANTEC PROJECT NUMBER: 171002316
 DATE: 5/17/2022
 SCDOT PIN: _____

SCALE IN FEET

PLANS NOT FOR CONSTRUCTION

APPLICATION BY: **SCDOT**
 SOUTH CAROLINA DEPARTMENT OF TRANSPORTATION

DORCHESTER COUNTY
 SC 165 (DELMAR HIGHWAY)
 IMPACT PLAN VIEW
 404 PERMIT DRAWINGS

SCALE: 1" = 100'

SHEET 12 OF 35

COUNTY	ROUTE NO.	ROUTE NAME	SHEET NO.
DORCHESTER	SC 165	DELMAR HIGHWAY	6A

SC 165 (DELMAR HIGHWAY) STA. 97+37.31

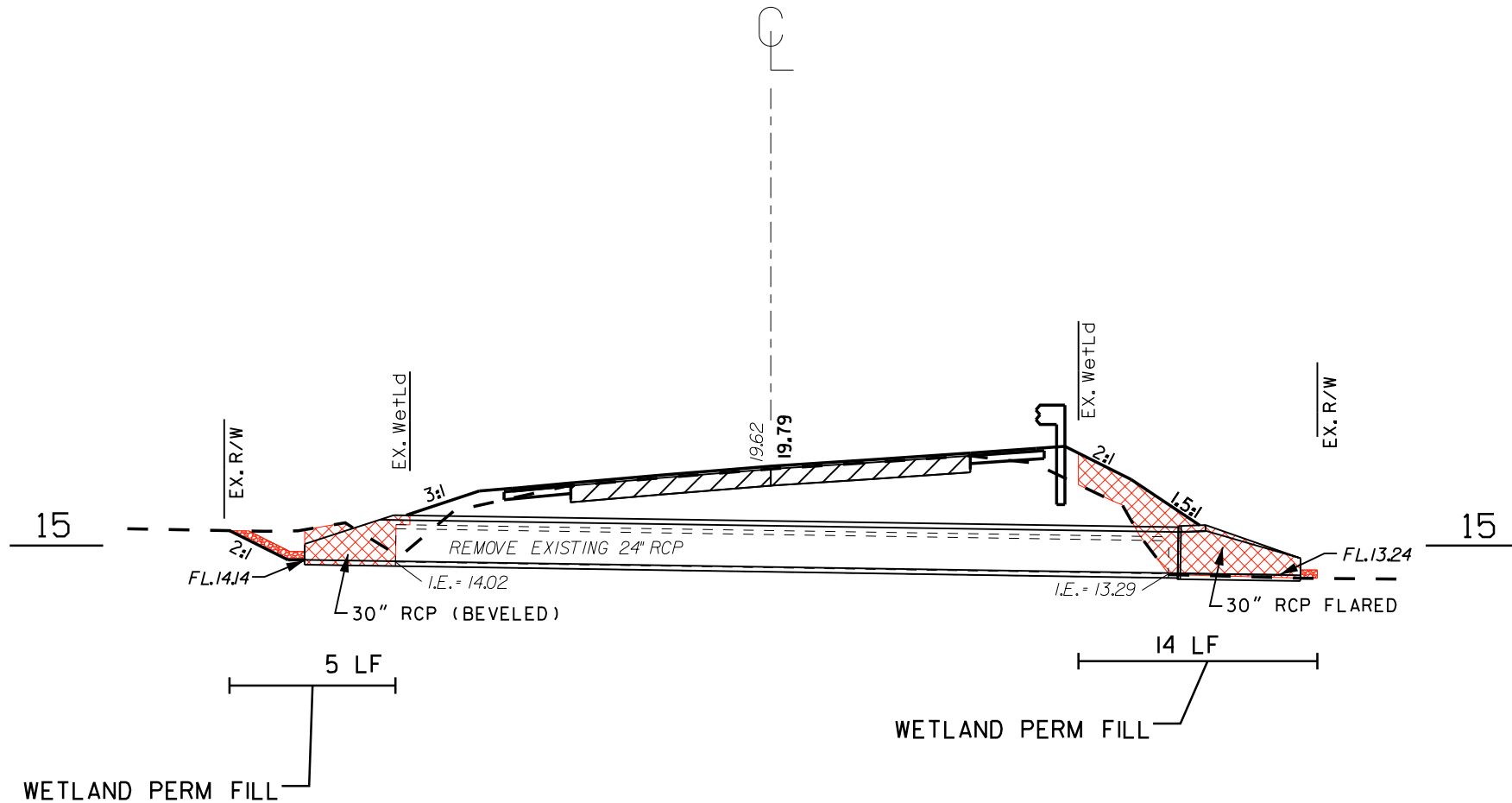

WETLAND PERMANENT FILL IMPACT



WETLAND PERMANENT EXCAVATION IMPACT

PREPARED BY:



Stantec Consulting Services
4969 Centre Pointe Drive, Suite 200
North Charleston, SC 29418
Tel: 843.740.7700
Fax: 843.740.7707
www.stantec.com

4			
3			
2			
1			
REV. NO.	BY	DATE	DESCRIPTION OF REVISION
STANTEC PROJECT NUMBER: 171002316			
DATE: 05/17/2022			
SCDOT PIN: _____			

APPLICATION BY: **SCDOT**
SOUTH CAROLINA DEPARTMENT OF TRANSPORTATION

DORCHESTER COUNTY
SC 165 (DELMAR HIGHWAY)
PROJECT ID P038365
404 PERMIT DRAWINGS

SCALE: N.T.S. SHEET 13 OF 35

COUNTY	ROUTE NO.	ROUTE NAME	SHEET NO.
DORCHESTER	SC 165	DELMAR HIGHWAY	7

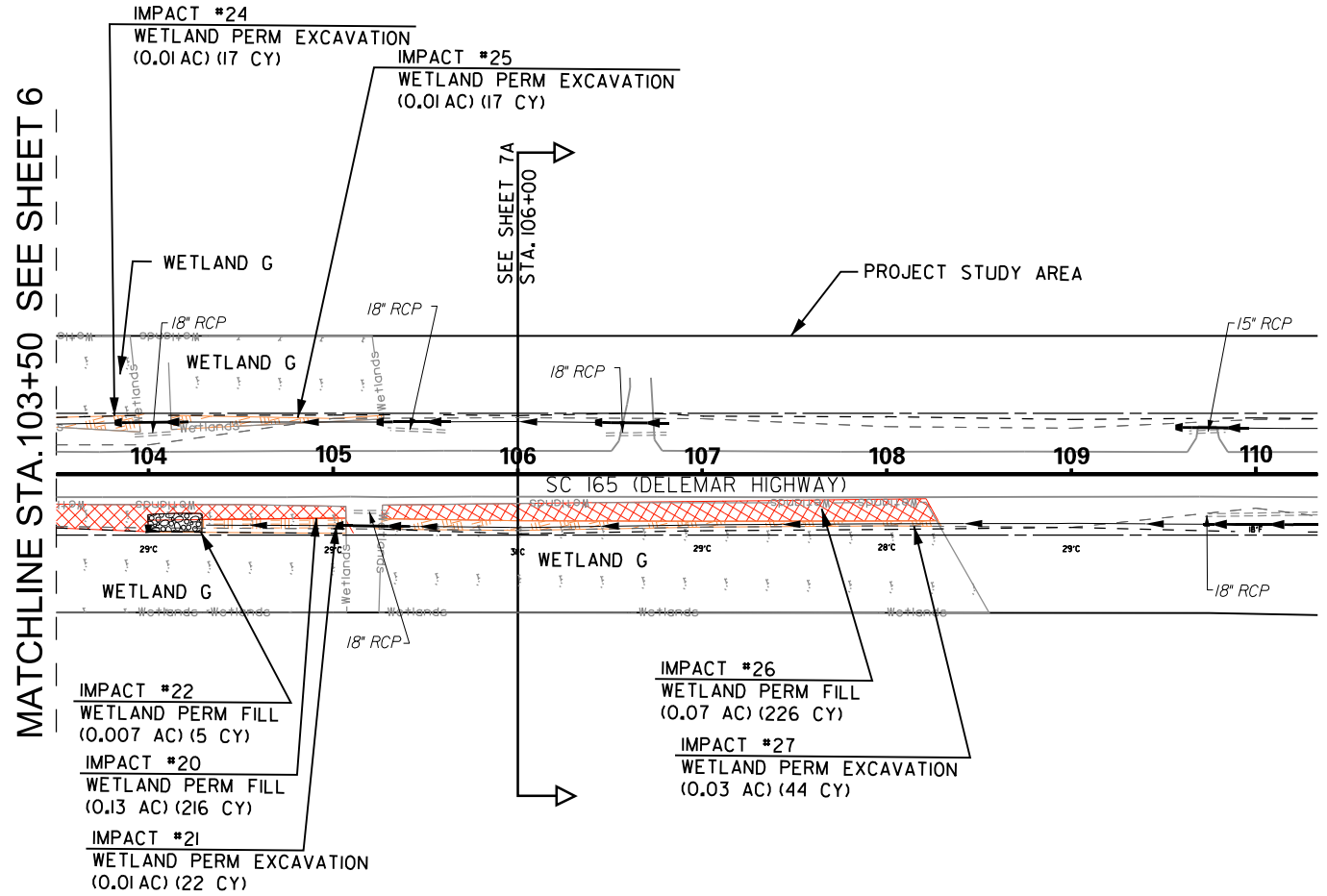
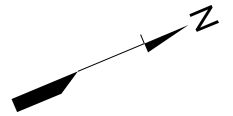

MATCHLINE STA. 103+50 SEE SHEET 6

LEGEND	
FILL/CUT LIMIT	---
OPEN WATER	
WETLAND	
RPW STREAM	
PERMANENT WETLAND EXCAVATION IMPACT	
PERMANENT WETLAND FILL IMPACT	

PREPARED BY:
Stantec
 Stantec Consulting Services
 4969 Centre Pointe Drive, Suite 200
 North Charleston, SC 29418
 Tel: 843.740.7700
 Fax: 843.740.7707
 www.stantec.com

REV. NO.	BY	DATE	DESCRIPTION OF REVISION
4			
3			
2			
1			

STANTEC PROJECT NUMBER: 171002316
 DATE: 5/17/2022
 SCDOT PIN: _____

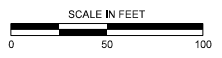

PLANS NOT FOR CONSTRUCTION

APPLICATION BY: **SCDOT**
 SOUTH CAROLINA DEPARTMENT OF TRANSPORTATION

DORCHESTER COUNTY
 SC 165 (DELMAR HIGHWAY)
 IMPACT PLAN VIEW
 404 PERMIT DRAWINGS

SCALE: 1" = 100'
 SHEET 14 OF 35

COUNTY	ROUTE NO.	ROUTE NAME	SHEET NO.
DORCHESTER	SC 165	DELMAR HIGHWAY	7A

SC 165 (DELMAR HIGHWAY) STA. 106+00.00

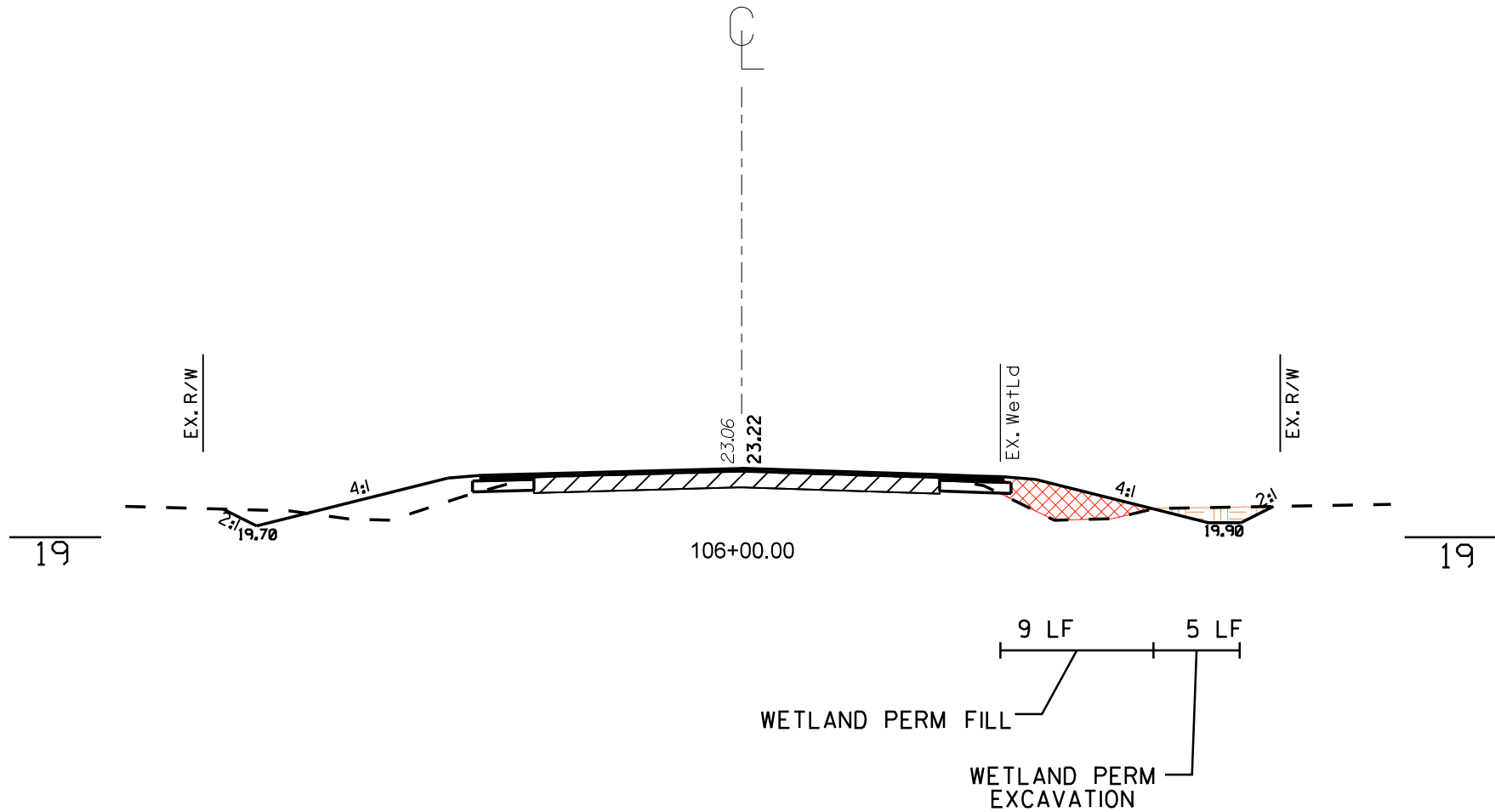

WETLAND PERMANENT FILL IMPACT



WETLAND PERMANENT EXCAVATION IMPACT

PREPARED BY:



Stantec Consulting Services
4969 Centre Pointe Drive, Suite 200
North Charleston, SC 29418
Tel: 843.740.7700
Fax: 843.740.7707
www.stantec.com

4			
3			
2			
1			
REV. NO.	BY	DATE	DESCRIPTION OF REVISION
STANTEC PROJECT NUMBER: 171002316			
DATE: 05/17/2022			
SCDOT PIN: _____			

APPLICATION BY: **SCDOT**
SOUTH CAROLINA DEPARTMENT OF TRANSPORTATION
DORCHESTER COUNTY
SC 165 (DELMAR HIGHWAY)
PROJECT ID P038365
404 PERMIT DRAWINGS
SCALE: N.T.S. SHEET 15 OF 35

COUNTY	ROUTE NO.	ROUTE NAME	SHEET NO.
DORCHESTER	SC 165	DELMAR HIGHWAY	8

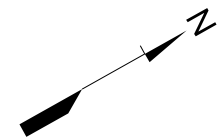

MATCHLINE STA. 129+50 SEE SHEET 9

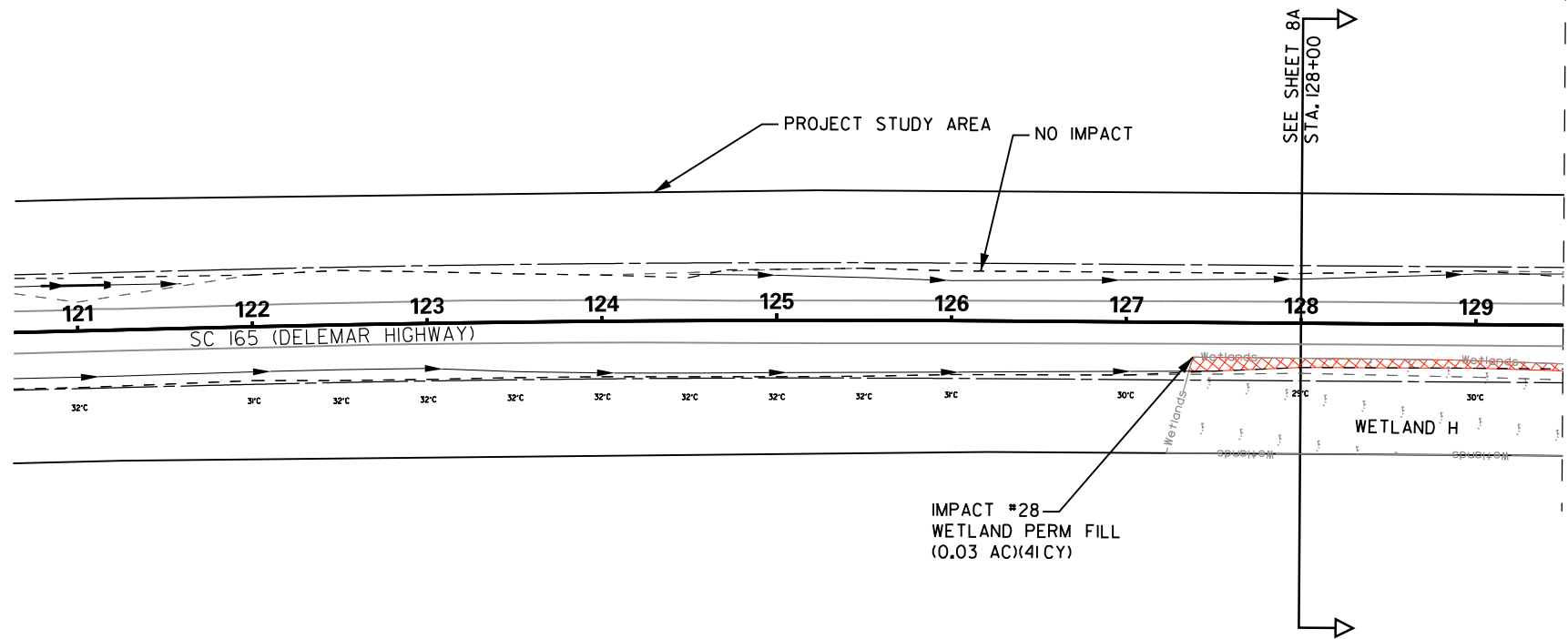

LEGEND	
FILL/CUT LIMIT	----
OPEN WATER	
WETLAND	
RPW STREAM	SP
PERMANENT WETLAND EXCAVATION IMPACT	
PERMANENT WETLAND FILL IMPACT	

PREPARED BY:
Stantec
 Stantec Consulting Services
 4969 Centre Pointe Drive, Suite 200
 North Charleston, SC 29418
 Tel: 843.740.7700
 Fax: 843.740.7707
 www.stantec.com

REV. NO.	BY	DATE	DESCRIPTION OF REVISION
4			
3			
2			
1			

STANTEC PROJECT NUMBER: 171002316
 DATE: 5/17/2022
 SCDOT PIN: _____

SCALE IN FEET

PLANS NOT FOR CONSTRUCTION

APPLICATION BY: **SCDOT**
 SOUTH CAROLINA DEPARTMENT OF TRANSPORTATION

DORCHESTER COUNTY
 SC 165 (DELMAR HIGHWAY)
 IMPACT PLAN VIEW
 404 PERMIT DRAWINGS

SCALE: 1" = 100' SHEET 16 OF 35

COUNTY	ROUTE NO.	ROUTE NAME	SHEET NO.
DORCHESTER	SC 165	DELMAR HIGHWAY	8A

SC 165 (DELMAR HIGHWAY) STA. 128+00.00

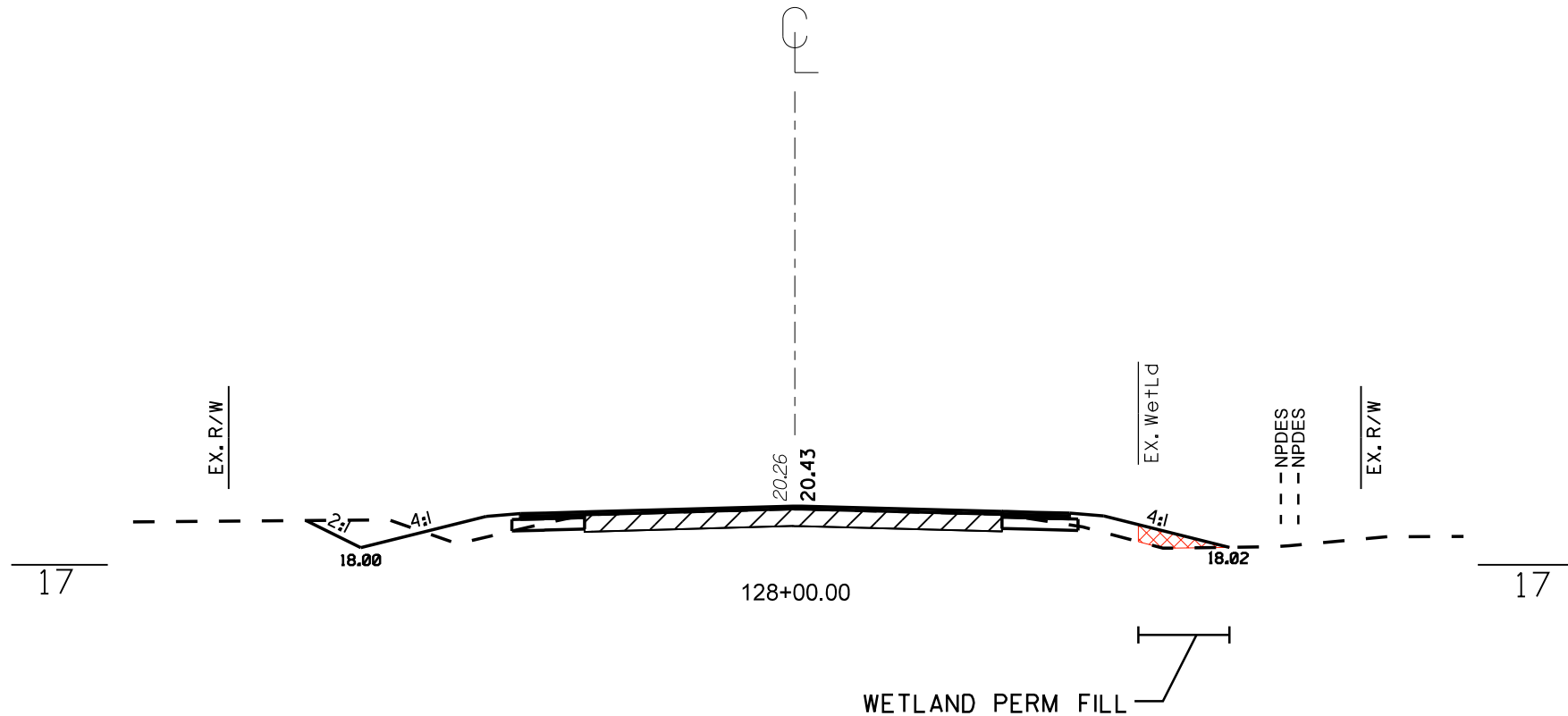

WETLAND PERMANENT FILL IMPACT



WETLAND PERMANENT EXCAVATION IMPACT

PREPARED BY:



Stantec Consulting Services
4969 Centre Pointe Drive, Suite 200
North Charleston, SC 29418
Tel: 843.740.7700
Fax: 843.740.7707
www.stantec.com

4			
3			
2			
1			
REV. NO.	BY	DATE	DESCRIPTION OF REVISION
STANTEC PROJECT NUMBER: 171002316			
DATE: 05/17/2022			
SCDOT PIN: _____			

APPLICATION BY: **SCDOT**
SOUTH CAROLINA DEPARTMENT OF TRANSPORTATION

DORCHESTER COUNTY
SC 165 (DELMAR HIGHWAY)
PROJECT ID P038365
404 PERMIT DRAWINGS

SCALE: N.T.S. SHEET 17 OF 35

COUNTY	ROUTE NO.	ROUTE NAME	SHEET NO.
DORCHESTER	SC 165	DELMAR HIGHWAY	9

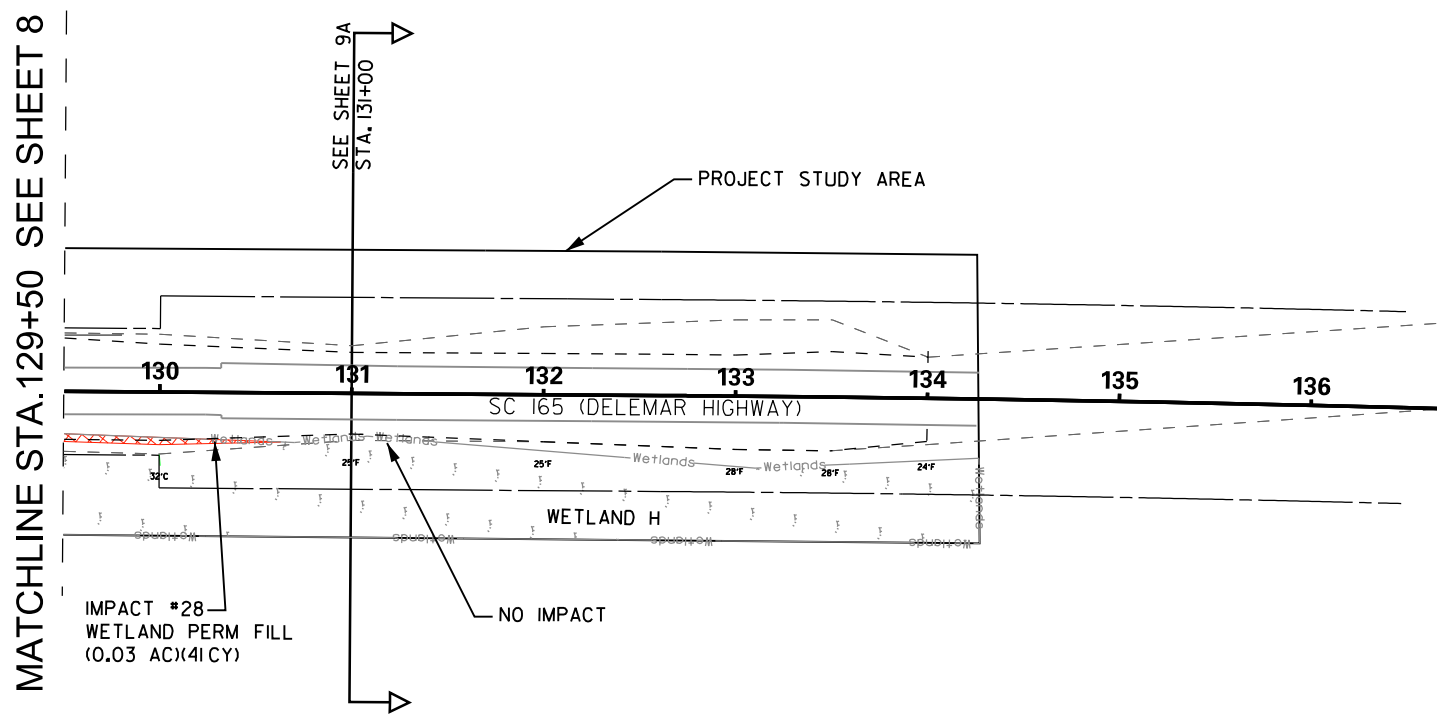
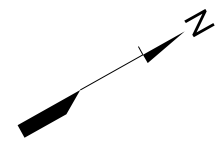

MATCHLINE STA. 129+50 SEE SHEET 8

SEE SHEET 9A
STA. 131+00

PROJECT STUDY AREA

130 131 132 133 134 135 136

SC 165 (DELMAR HIGHWAY)

WETLAND H

IMPACT #28
WETLAND PERM FILL
(0.03 AC)(41 CY)

NO IMPACT

LEGEND

FILL/CUT LIMIT	----
OPEN WATER	
WETLAND	
RPW STREAM	SP
PERMANENT WETLAND EXCAVATION IMPACT	
PERMANENT WETLAND FILL IMPACT	

PREPARED BY:
 Stantec
Stantec Consulting Services
4969 Centre Pointe Drive, Suite 200
North Charleston, SC 29418
Tel: 843.740.7700
Fax: 843.740.7707
www.stantec.com

4			
3			
2			
1			
REV. NO.	BY	DATE	DESCRIPTION OF REVISION
STANTEC PROJECT NUMBER: 171002316			
DATE: 5/17/2022			
SCDOT PIN: _____			

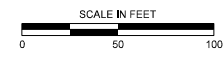

PLANS NOT FOR CONSTRUCTION

APPLICATION BY: **SCDOT**
SOUTH CAROLINA DEPARTMENT OF TRANSPORTATION
DORCHESTER COUNTY
SC 165 (DELMAR HIGHWAY)
IMPACT PLAN VIEW
404 PERMIT DRAWINGS
SCALE: 1" = 100' SHEET 18 OF 35

COUNTY	ROUTE NO.	ROUTE NAME	SHEET NO.
DORCHESTER	SC 165	DELMAR HIGHWAY	9A

SC 165 (DELMAR HIGHWAY) STA. 131+00.00

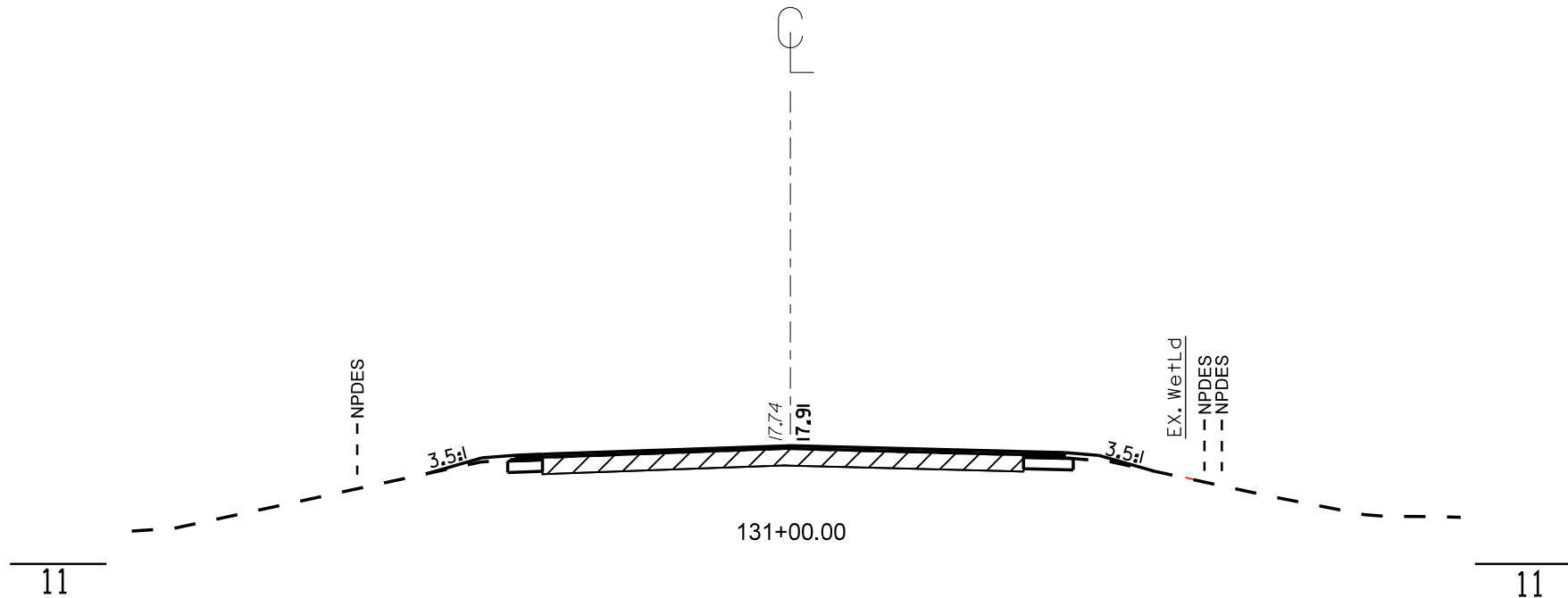

WETLAND PERMANENT FILL IMPACT



WETLAND PERMANENT EXCAVATION IMPACT

PREPARED BY:



Stantec Consulting Services
4969 Centre Pointe Drive, Suite 200
North Charleston, SC 29418
Tel: 843.740.7700
Fax: 843.740.7707
www.stantec.com

4			
3			
2			
1			
REV. NO.	BY	DATE	DESCRIPTION OF REVISION
STANTEC PROJECT NUMBER: 171002316			
DATE: 05/17/2022			
SCDOT PIN: _____			

APPLICATION BY: SCDOT
SOUTH CAROLINA DEPARTMENT OF TRANSPORTATION
DORCHESTER COUNTY
SC 165 (DELMAR HIGHWAY)
PROJECT ID P038365
404 PERMIT DRAWINGS
SCALE: N.T.S.
SHEET 19 OF 35

COUNTY	ROUTE NO.	ROUTE NAME	SHEET NO.
DORCHESTER	SC 165	DELMAR HIGHWAY	10

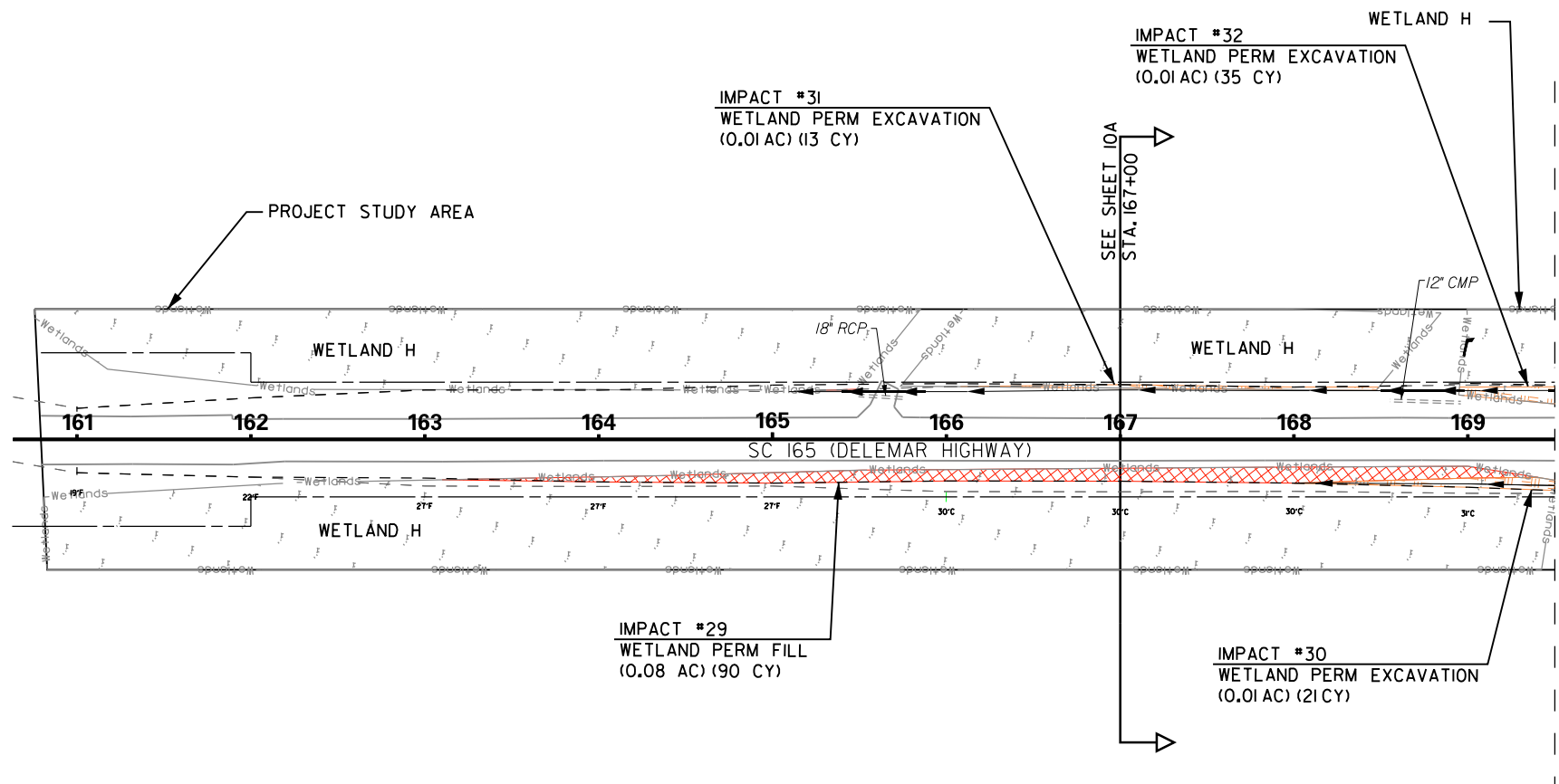
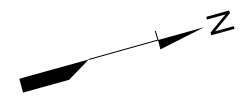

MATCHLINE STA. 169+50 SEE SHEET 11

LEGEND	
FILL/CUT LIMIT	---
OPEN WATER	
WETLAND	
RPW STREAM	
PERMANENT WETLAND EXCAVATION IMPACT	
PERMANENT WETLAND FILL IMPACT	

PREPARED BY:
Stantec
 Stantec Consulting Services
 4969 Centre Pointe Drive, Suite 200
 North Charleston, SC 29418
 Tel: 843.740.7700
 Fax: 843.740.7707
 www.stantec.com

REV. NO.	BY	DATE	DESCRIPTION OF REVISION
4			
3			
2			
1			

STANTEC PROJECT NUMBER: 171002316
 DATE: 5/17/2022
 SCDOT PIN: _____

SCALE IN FEET

PLANS NOT FOR CONSTRUCTION

APPLICATION BY: **SCDOT**
 SOUTH CAROLINA DEPARTMENT OF TRANSPORTATION

DORCHESTER COUNTY
 SC 165 (DELMAR HIGHWAY)
 IMPACT PLAN VIEW
 404 PERMIT DRAWINGS

SCALE: 1" = 100'
 SHEET 20 OF 35

COUNTY	ROUTE NO.	ROUTE NAME	SHEET NO.
DORCHESTER	SC 165	DELMAR HIGHWAY	10A

SC 165 (DELMAR HIGHWAY) STA. 167+00.00

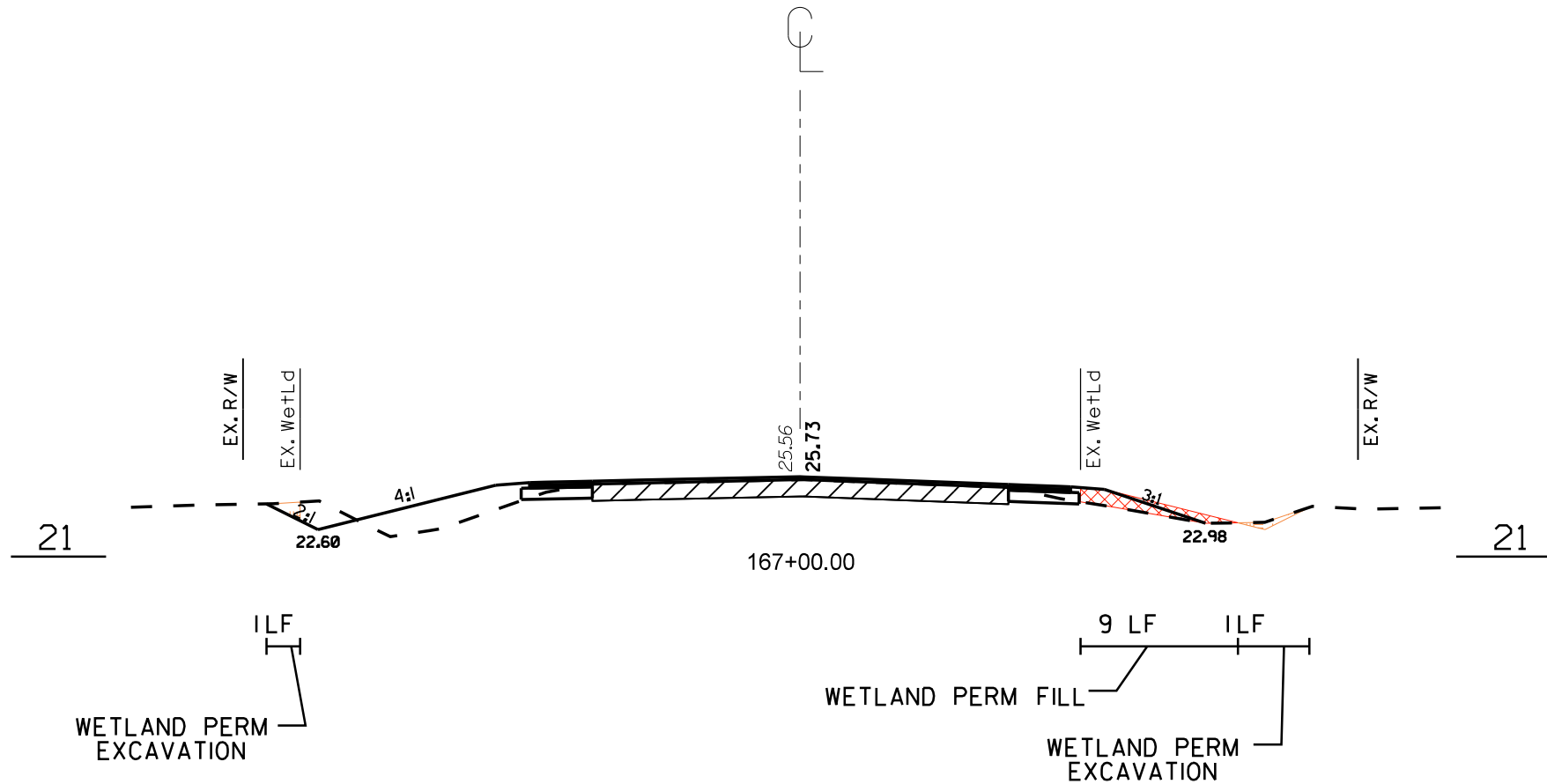

WETLAND PERMANENT FILL IMPACT



WETLAND PERMANENT EXCAVATION IMPACT

PREPARED BY:



Stantec Consulting Services
4969 Centre Pointe Drive, Suite 200
North Charleston, SC 29418
Tel: 843.740.7700
Fax: 843.740.7707
www.stantec.com

4			
3			
2			
1			
REV. NO.	BY	DATE	DESCRIPTION OF REVISION
STANTEC PROJECT NUMBER: 171002316			
DATE: 05/17/2022			
SCDOT PIN: _____			

APPLICATION BY: **SCDOT**
SOUTH CAROLINA DEPARTMENT OF TRANSPORTATION

DORCHESTER COUNTY
SC 165 (DELMAR HIGHWAY)
PROJECT ID P038365
404 PERMIT DRAWINGS

SCALE: N.T.S. SHEET 21 OF 35

COUNTY	ROUTE NO.	ROUTE NAME	SHEET NO.
DORCHESTER	SC 165	DELMAR HIGHWAY	11



MATCHLINE STA. 169+50 SEE SHEET 10

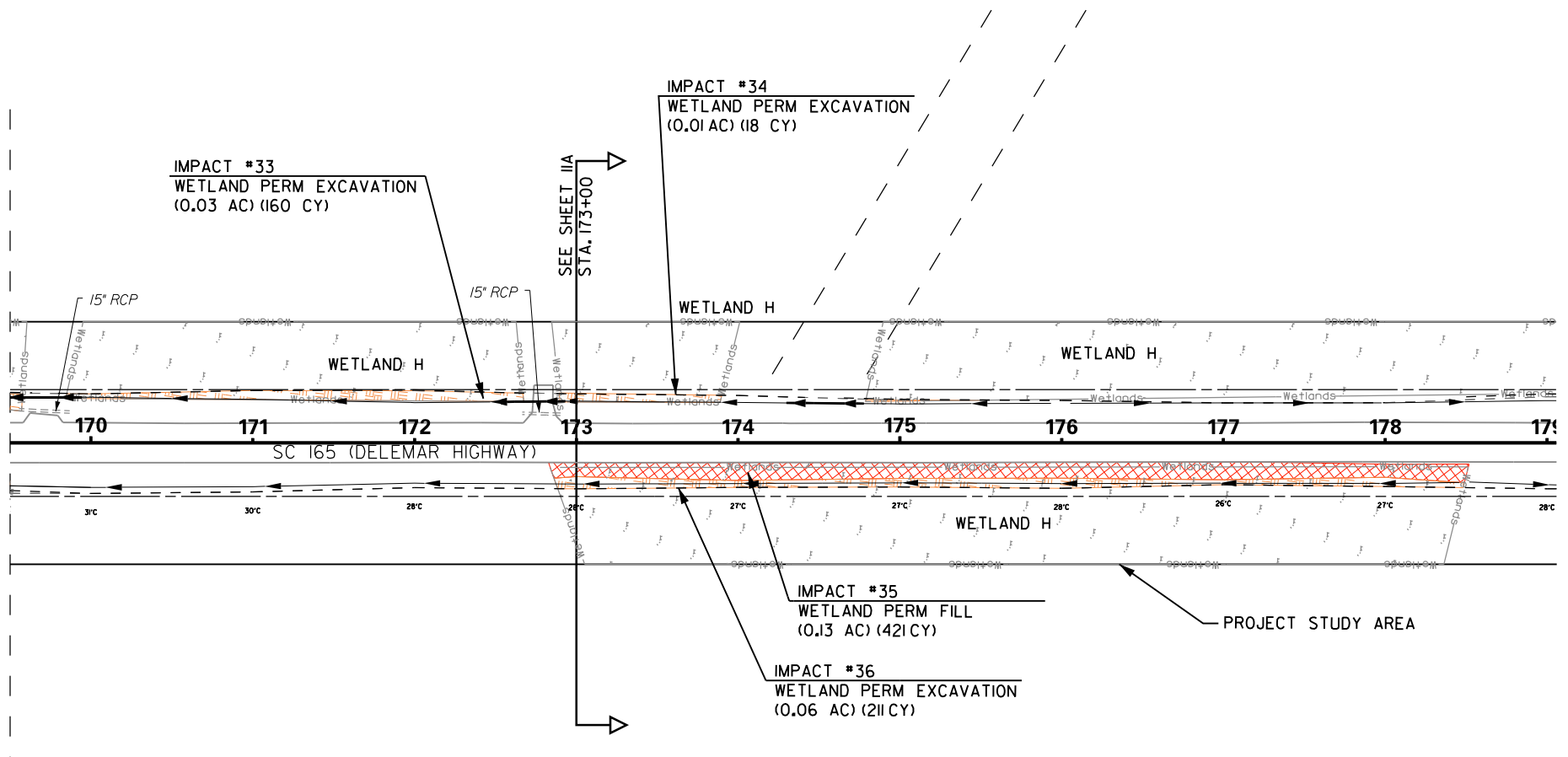

LEGEND	
FILL/CUT LIMIT	----
OPEN WATER	
WETLAND	
RPW STREAM	SP
PERMANENT WETLAND EXCAVATION IMPACT	
PERMANENT WETLAND FILL IMPACT	

PREPARED BY:
Stantec
 Stantec Consulting Services
 4969 Centre Pointe Drive, Suite 200
 North Charleston, SC 29418
 Tel: 843.740.7700
 Fax: 843.740.7707
 www.stantec.com

REV. NO.	BY	DATE	DESCRIPTION OF REVISION
4			
3			
2			
1			

STANTEC PROJECT NUMBER: 171002316
 DATE: 5/17/2022
 SCDOT PIN: _____

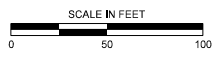

PLANS NOT FOR CONSTRUCTION

APPLICATION BY: **SCDOT**
 SOUTH CAROLINA DEPARTMENT OF TRANSPORTATION

DORCHESTER COUNTY
 SC 165 (DELMAR HIGHWAY)
 IMPACT PLAN VIEW
 404 PERMIT DRAWINGS

SCALE: 1" = 100'
 SHEET 22 OF 35

COUNTY	ROUTE NO.	ROUTE NAME	SHEET NO.
DORCHESTER	SC 165	DELMAR HIGHWAY	11A

SC 165 (DELMAR HIGHWAY) STA. 173+00.00

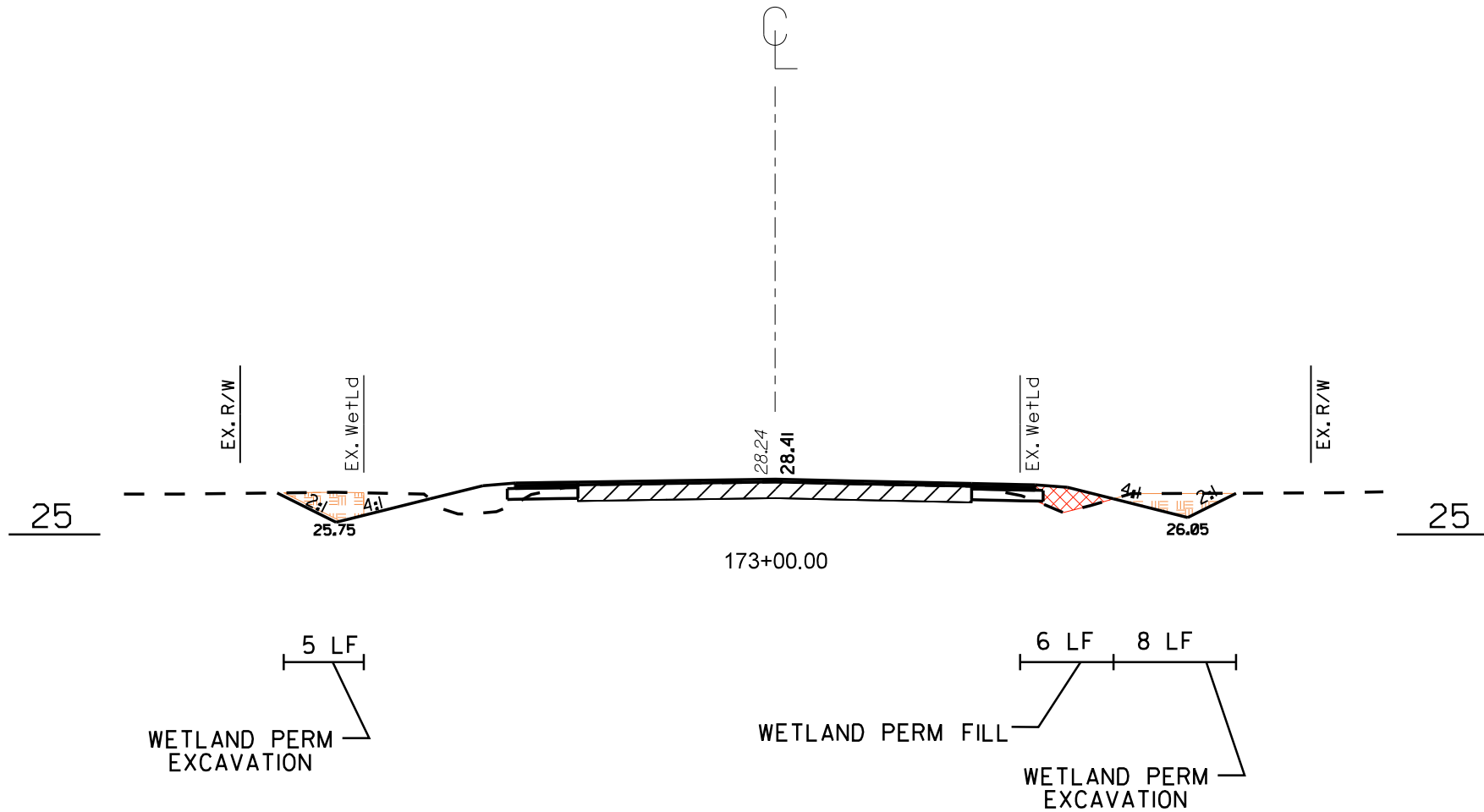

WETLAND PERMANENT FILL IMPACT



WETLAND PERMANENT EXCAVATION IMPACT

PREPARED BY:



Stantec Consulting Services
4969 Centre Pointe Drive, Suite 200
North Charleston, SC 29418
Tel: 843.740.7700
Fax: 843.740.7707
www.stantec.com

4			
3			
2			
1			
REV. NO.	BY	DATE	DESCRIPTION OF REVISION
STANTEC PROJECT NUMBER: 171002316			
DATE: 05/17/2022			
SCDOT PIN: _____			

APPLICATION BY: **SCDOT**
SOUTH CAROLINA DEPARTMENT OF TRANSPORTATION

DORCHESTER COUNTY
SC 165 (DELMAR HIGHWAY)
PROJECT ID P038365
404 PERMIT DRAWINGS

SCALE: N.T.S. SHEET 23 OF 35

COUNTY	ROUTE NO.	ROUTE NAME	SHEET NO.
DORCHESTER	SC 165	DELMAR HIGHWAY	12

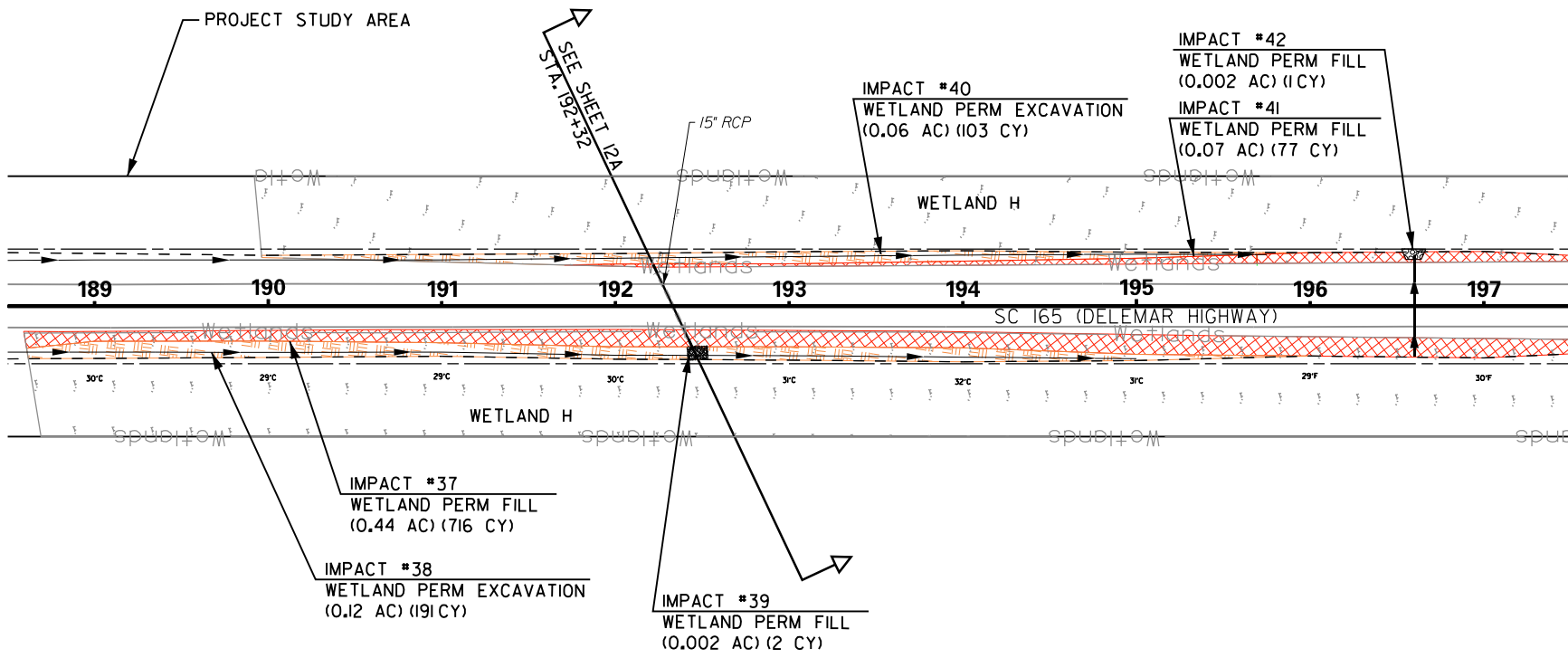
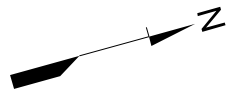

MATCHLINE STA. 197+50 SEE SHEET 13

LEGEND	
FILL/CUT LIMIT	----
OPEN WATER	
WETLAND	
RPW STREAM	SP
PERMANENT WETLAND EXCAVATION IMPACT	
PERMANENT WETLAND FILL IMPACT	

PREPARED BY:
Stantec
 Stantec Consulting Services
 4969 Centre Pointe Drive, Suite 200
 North Charleston, SC 29418
 Tel: 843.740.7700
 Fax: 843.740.7707
 www.stantec.com

REV. NO.	BY	DATE	DESCRIPTION OF REVISION
4			
3			
2			
1			

STANTEC PROJECT NUMBER: 171002316
 DATE: 5/17/2022
 SCDOT PIN: _____

SCALE IN FEET

PLANS NOT FOR CONSTRUCTION

APPLICATION BY: **SCDOT**
 SOUTH CAROLINA DEPARTMENT OF TRANSPORTATION

DORCHESTER COUNTY
 SC 165 (DELMAR HIGHWAY)
 IMPACT PLAN VIEW
 404 PERMIT DRAWINGS

SCALE: 1" = 100' SHEET 24 OF 35

COUNTY	ROUTE NO.	ROUTE NAME	SHEET NO.
DORCHESTER	SC 165	DELMAR HIGHWAY	12A

SC 165 (DELMAR HIGHWAY) STA. 192+33.15

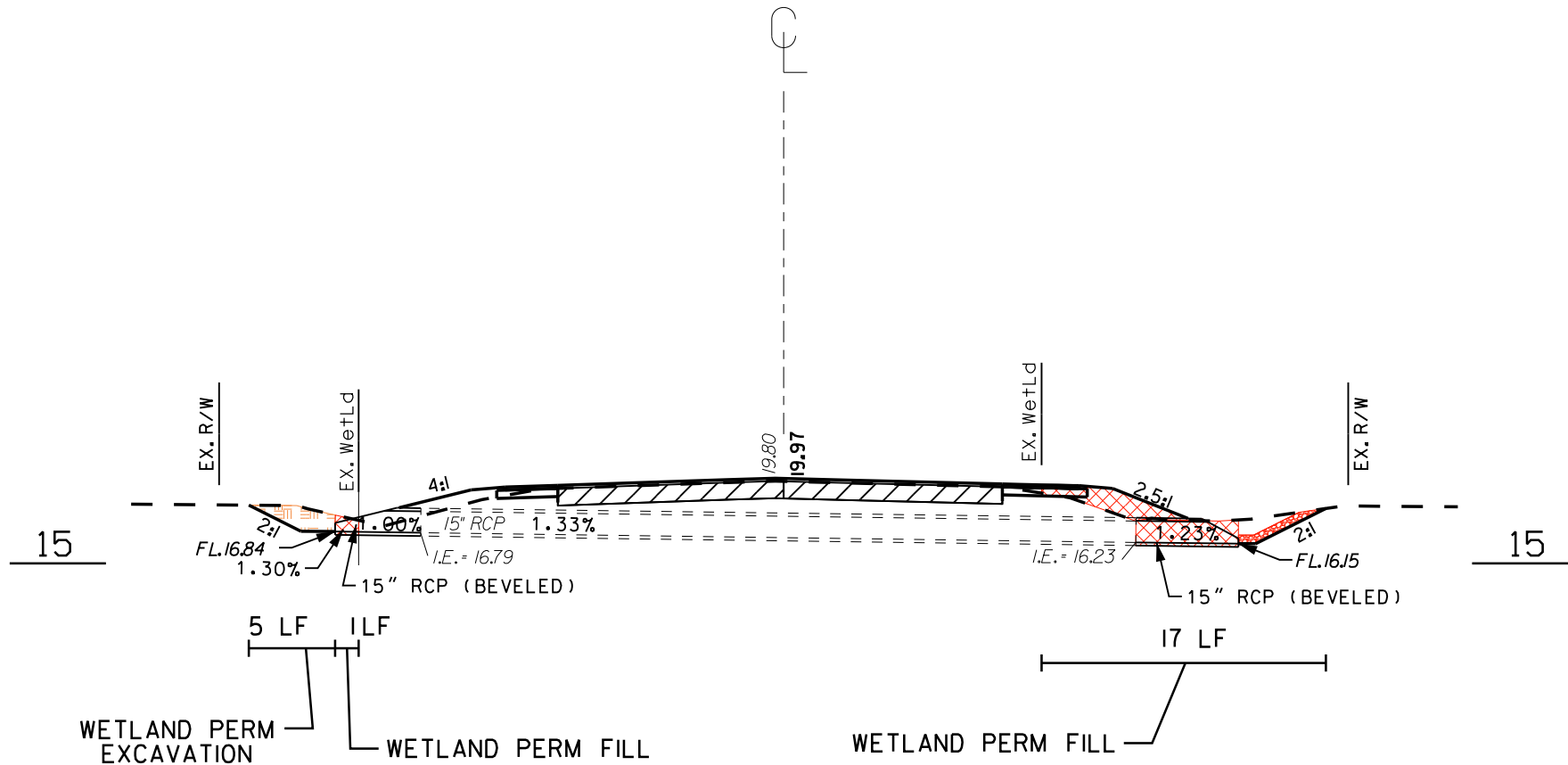

WETLAND PERMANENT FILL IMPACT



WETLAND PERMANENT EXCAVATION IMPACT

PREPARED BY:



Stantec Consulting Services
4969 Centre Pointe Drive, Suite 200
North Charleston, SC 29418
Tel: 843.740.7700
Fax: 843.740.7707
www.stantec.com

4			
3			
2			
1			
REV. NO.	BY	DATE	DESCRIPTION OF REVISION
STANTEC PROJECT NUMBER:		171002316	
DATE:		05/17/2022	
SCDOT PIN:			

APPLICATION BY: **SCDOT**
SOUTH CAROLINA DEPARTMENT OF TRANSPORTATION

DORCHESTER COUNTY
SC 165 (DELMAR HIGHWAY)
PROJECT ID P038365
404 PERMIT DRAWINGS

SCALE: N.T.S. SHEET 25 OF 35

COUNTY	ROUTE NO.	ROUTE NAME	SHEET NO.
DORCHESTER	SC 165	DELMAR HIGHWAY	13



MATCHLINE STA. 197+50 SEE SHEET 12

MATCHLINE STA. 206+50 SEE SHEET 14

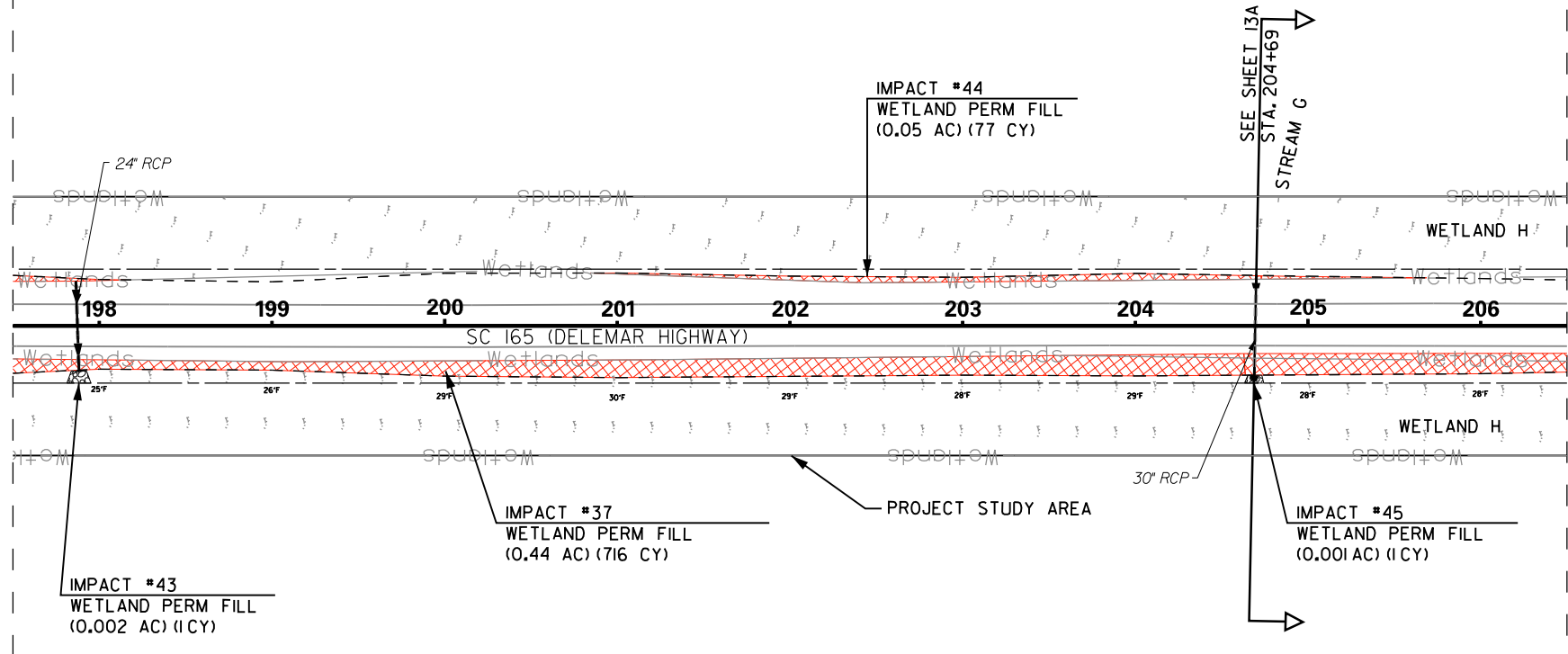

LEGEND

FILL/CUT LIMIT	----
OPEN WATER	
WETLAND	
RPW STREAM	SP
PERMANENT WETLAND EXCAVATION IMPACT	
PERMANENT WETLAND FILL IMPACT	

PREPARED BY:
Stantec
 Stantec Consulting Services
 4969 Centre Pointe Drive, Suite 200
 North Charleston, SC 29418
 Tel: 843.740.7700
 Fax: 843.740.7707
 www.stantec.com

REV. NO.	BY	DATE	DESCRIPTION OF REVISION
4			
3			
2			
1			
STANTEC PROJECT NUMBER: 171002316		SCALE IN FEET	
DATE: 5/17/2022			
SCDOT PIN: _____			



PLANS NOT FOR CONSTRUCTION

APPLICATION BY: **SCDOT**
 SOUTH CAROLINA DEPARTMENT OF TRANSPORTATION
 DORCHESTER COUNTY
 SC 165 (DELMAR HIGHWAY)
 IMPACT PLAN VIEW
 404 PERMIT DRAWINGS
 SCALE: 1" = 100' SHEET 26 OF 35

COUNTY	ROUTE NO.	ROUTE NAME	SHEET NO.
DORCHESTER	SC 165	DELMAR HIGHWAY	13A

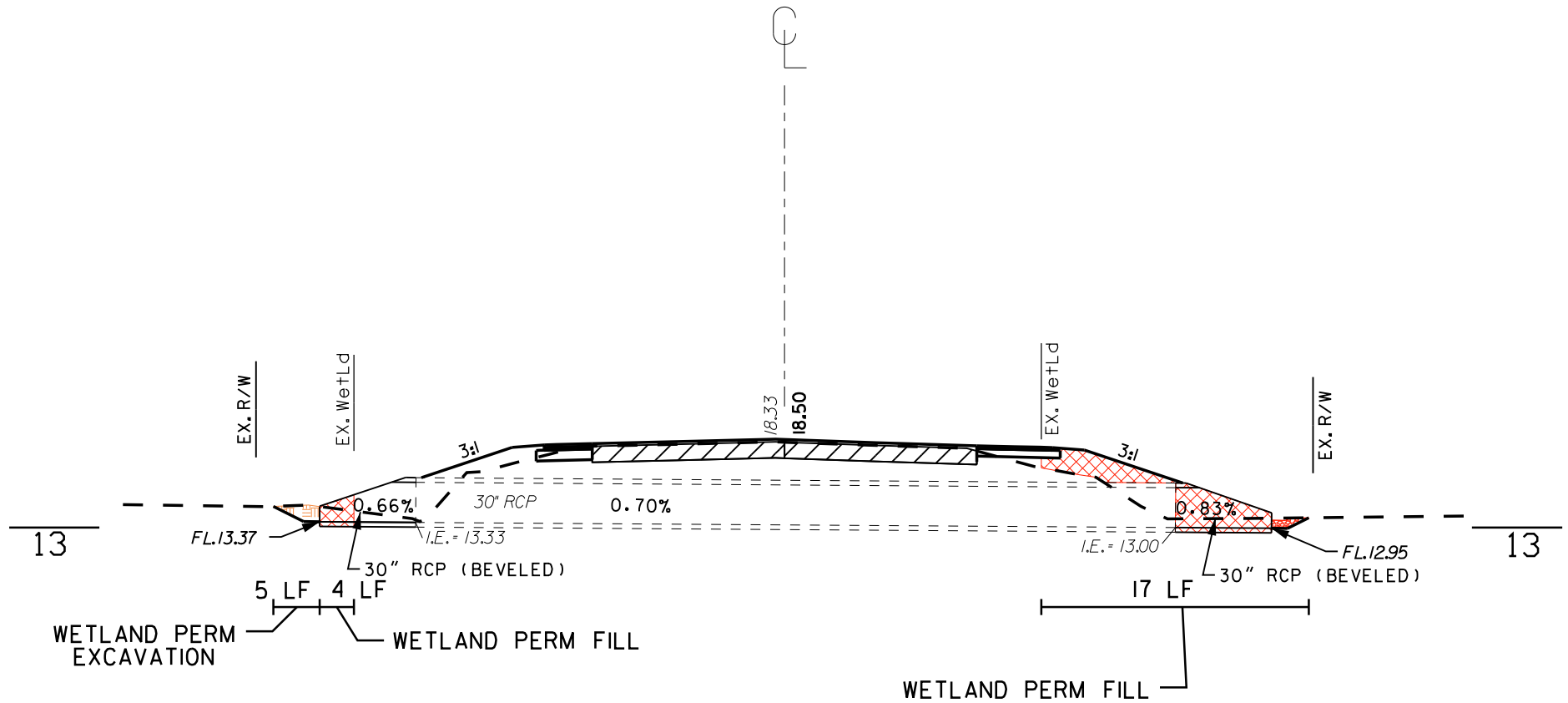
SC 165 (DELMAR HIGHWAY) STA. 204+69.56



 WETLAND PERMANENT FILL IMPACT
 WETLAND PERMANENT EXCAVATION IMPACT

PREPARED BY:

 Stantec Consulting Services
 4969 Centre Pointe Drive, Suite 200
 North Charleston, SC 29418
 Tel: 843.740.7700
 Fax: 843.740.7707
 www.stantec.com

4			
3			
2			
1			
REV. NO.	BY	DATE	DESCRIPTION OF REVISION
STANTEC PROJECT NUMBER: 171002316			
DATE: 05/17/2022			
SCDOT PIN: _____			

APPLICATION BY: **SCDOT**
 SOUTH CAROLINA DEPARTMENT OF TRANSPORTATION
 DORCHESTER COUNTY
 SC 165 (DELMAR HIGHWAY)
 PROJECT ID P038365
 404 PERMIT DRAWINGS
 SCALE: N.T.S. SHEET 27 OF 35

COUNTY	ROUTE NO.	ROUTE NAME	SHEET NO.
DORCHESTER	SC 165	DELMAR HIGHWAY	14

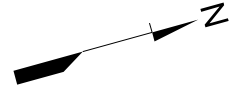

MATCHLINE STA. 206+50 SEE SHEET 13

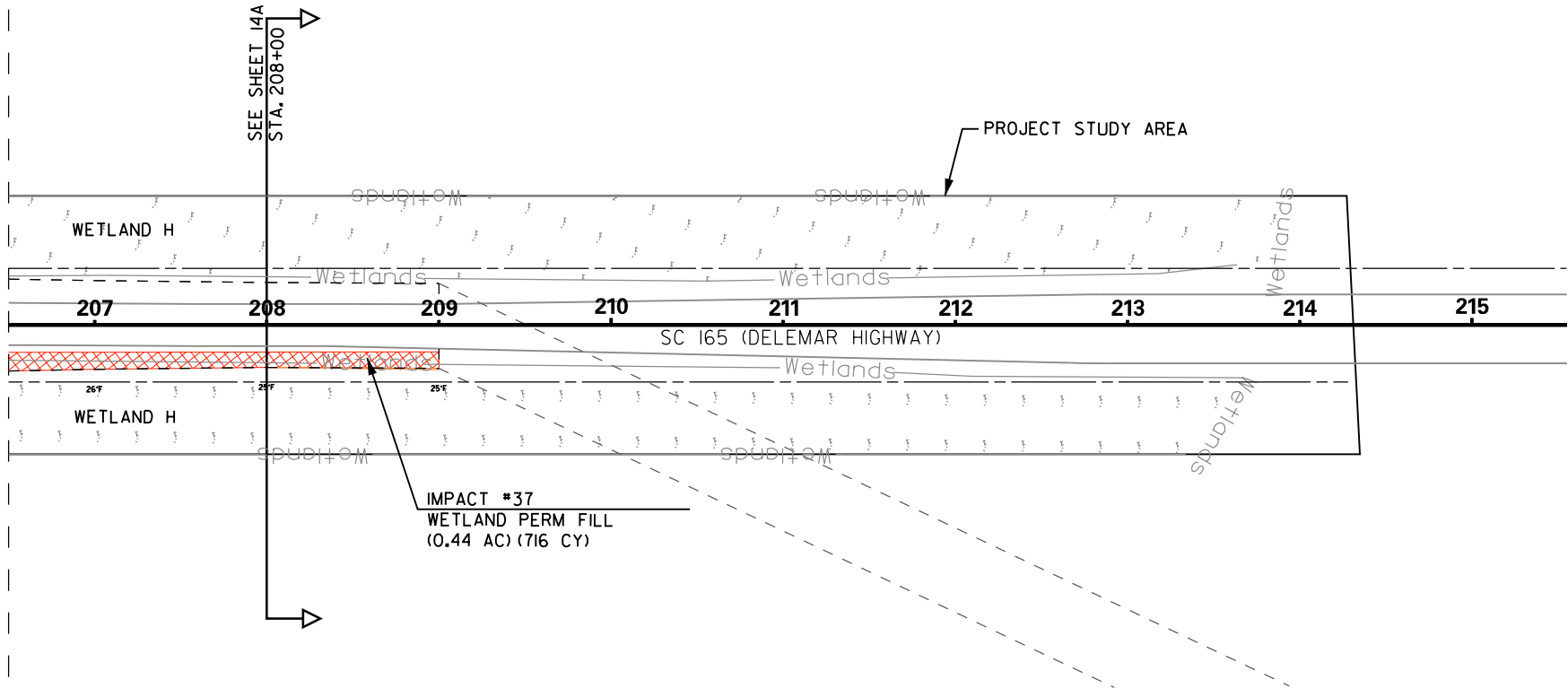

LEGEND	
FILL/CUT LIMIT	----
OPEN WATER	
WETLAND	
RPW STREAM	—SP—
PERMANENT WETLAND EXCAVATION IMPACT	
PERMANENT WETLAND FILL IMPACT	

PREPARED BY:
Stantec
 Stantec Consulting Services
 4969 Centre Pointe Drive, Suite 200
 North Charleston, SC 29418
 Tel: 843.740.7700
 Fax: 843.740.7707
 www.stantec.com

REV. NO.	BY	DATE	DESCRIPTION OF REVISION
4			
3			
2			
1			

STANTEC PROJECT NUMBER: 171002316
 DATE: 5/17/2022
 SCDOT PIN: _____

SCALE IN FEET

PLANS NOT FOR CONSTRUCTION

APPLICATION BY: **SCDOT**
 SOUTH CAROLINA DEPARTMENT OF TRANSPORTATION

DORCHESTER COUNTY
 SC 165 (DELMAR HIGHWAY)
 IMPACT PLAN VIEW
 404 PERMIT DRAWINGS

SCALE: 1" = 100' SHEET 28 OF 35

COUNTY	ROUTE NO.	ROUTE NAME	SHEET NO.
DORCHESTER	SC 165	DELMAR HIGHWAY	14A

SC 165 (DELMAR HIGHWAY) STA. 208+00.00

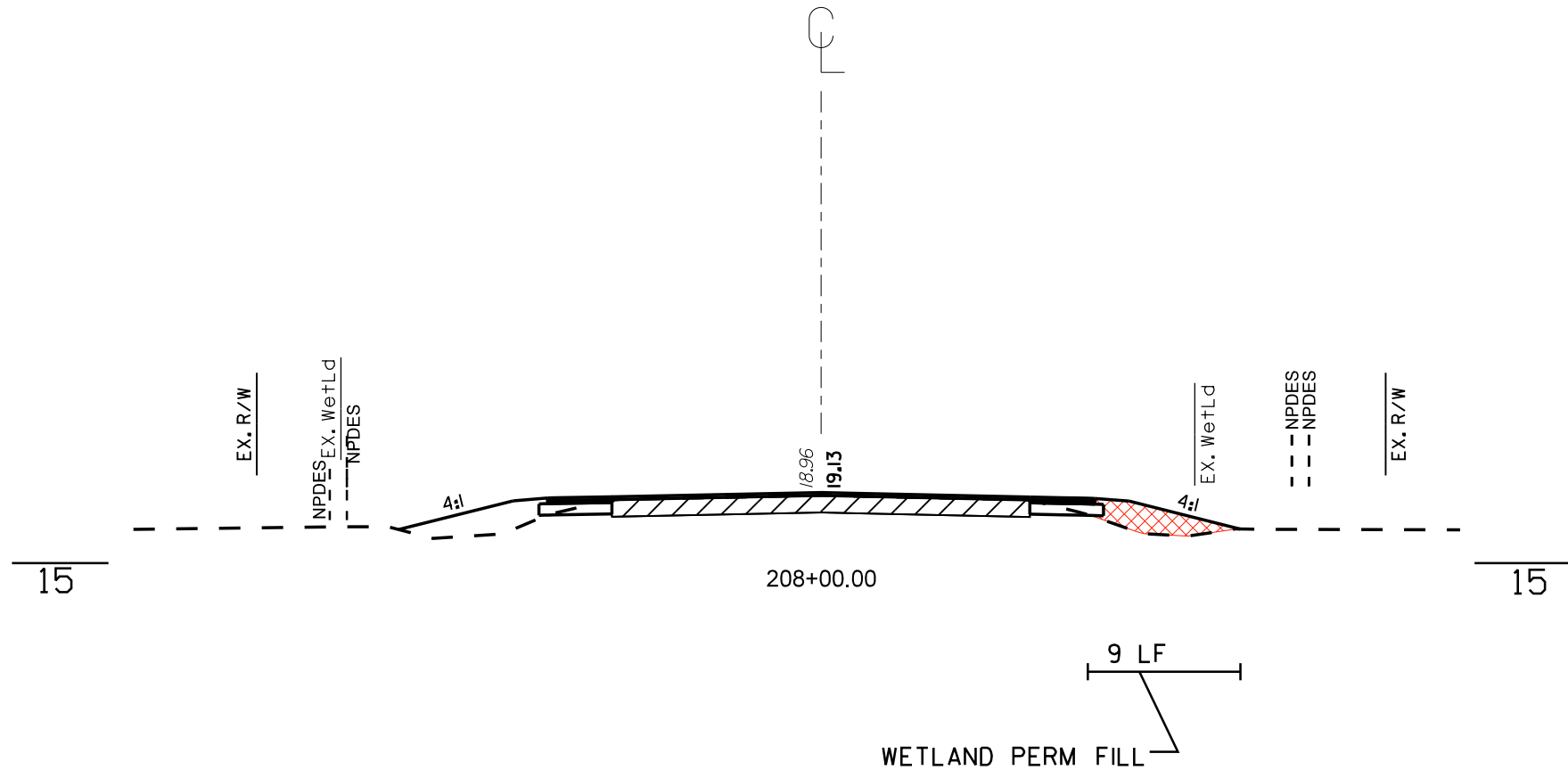

WETLAND PERMANENT FILL IMPACT



WETLAND PERMANENT EXCAVATION IMPACT

PREPARED BY:



Stantec Consulting Services
4969 Centre Pointe Drive, Suite 200
North Charleston, SC 29418
Tel: 843.740.7700
Fax: 843.740.7707
www.stantec.com

4			
3			
2			
1			
REV. NO.	BY	DATE	DESCRIPTION OF REVISION
STANTEC PROJECT NUMBER: 171002316			
DATE: 05/17/2022			
SCDOT PIN: _____			

APPLICATION BY: **SCDOT**
SOUTH CAROLINA DEPARTMENT OF TRANSPORTATION

DORCHESTER COUNTY
SC 165 (DELMAR HIGHWAY)
PROJECT ID P038365
404 PERMIT DRAWINGS

SCALE: N.T.S. SHEET 29 OF 35

COUNTY	ROUTE NO.	ROUTE NAME	SHEET NO.
DORCHESTER	SC 165	DELMAR HIGHWAY	15

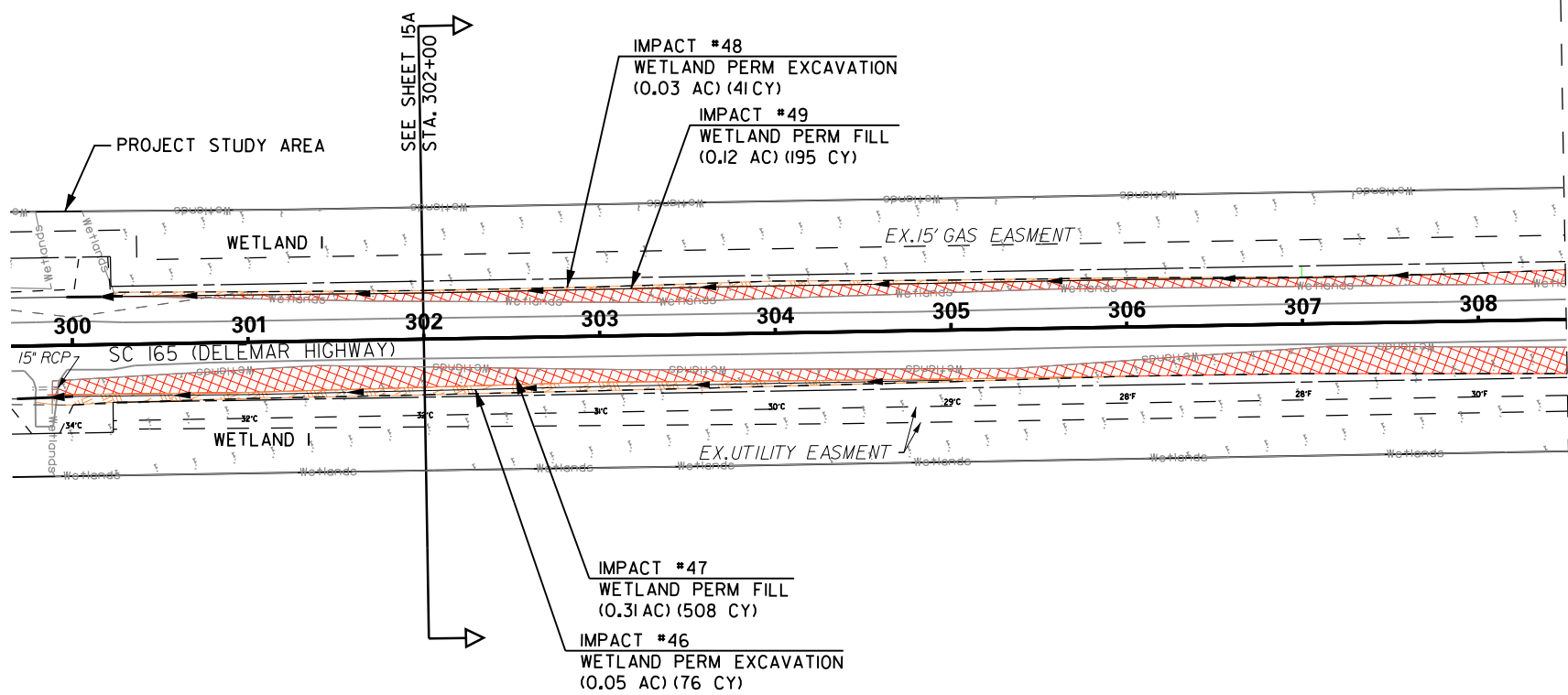
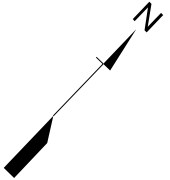

MATCHLINE STA. 308+50 SEE SHEET 16

LEGEND	
FILL/CUT LIMIT	----
OPEN WATER	
WETLAND	
RPW STREAM	SP
PERMANENT WETLAND EXCAVATION IMPACT	
PERMANENT WETLAND FILL IMPACT	

PREPARED BY:
Stantec
 Stantec Consulting Services
 4969 Centre Pointe Drive, Suite 200
 North Charleston, SC 29418
 Tel: 843.740.7700
 Fax: 843.740.7707
 www.stantec.com

REV. NO.	BY	DATE	DESCRIPTION OF REVISION
4			
3			
2			
1			

STANTEC PROJECT NUMBER: 171002316
 DATE: 5/17/2022
 SCDOT PIN: _____

SCALE IN FEET

PLANS NOT FOR CONSTRUCTION

APPLICATION BY: **SCDOT**
 SOUTH CAROLINA DEPARTMENT OF TRANSPORTATION

DORCHESTER COUNTY
 SC 165 (DELMAR HIGHWAY)
 IMPACT PLAN VIEW
 404 PERMIT DRAWINGS

SCALE: 1" = 100' SHEET 30 OF 35

COUNTY	ROUTE NO.	ROUTE NAME	SHEET NO.
DORCHESTER	SC 165	DELMAR HIGHWAY	15A

SC 165 (DELMAR HIGHWAY) STA. 302+00.00

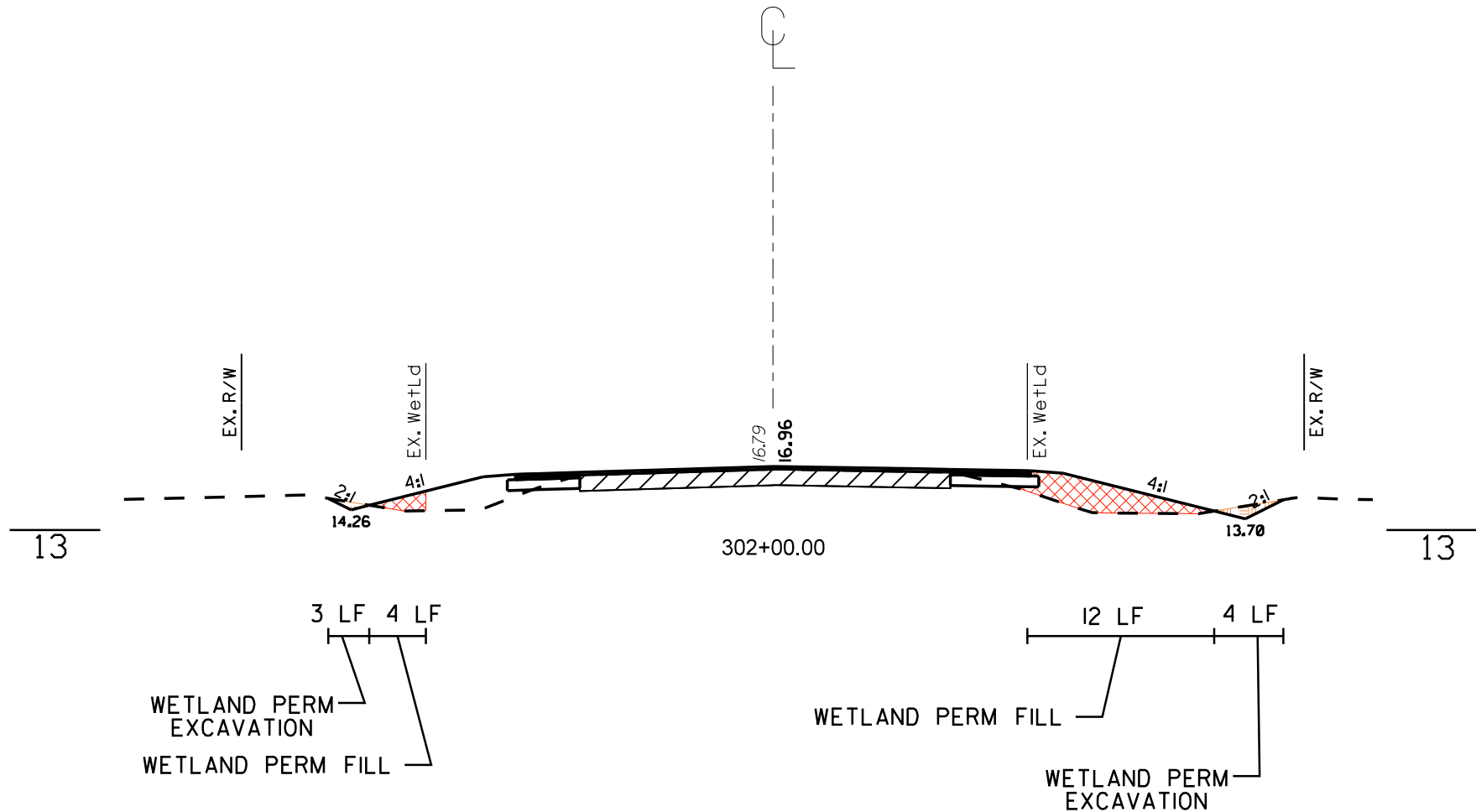

WETLAND PERMANENT FILL IMPACT



WETLAND PERMANENT EXCAVATION IMPACT

PREPARED BY:



Stantec Consulting Services
4969 Centre Pointe Drive, Suite 200
North Charleston, SC 29418
Tel: 843.740.7700
Fax: 843.740.7707
www.stantec.com

4			
3			
2			
1			
REV. NO.	BY	DATE	DESCRIPTION OF REVISION
STANTEC PROJECT NUMBER: 171002316			
DATE: 05/17/2022			
SCDOT PIN: _____			

APPLICATION BY: **SCDOT**
SOUTH CAROLINA DEPARTMENT OF TRANSPORTATION

DORCHESTER COUNTY
SC 165 (DELMAR HIGHWAY)
PROJECT ID P038365
404 PERMIT DRAWINGS

SCALE: N.T.S. SHEET 31 OF 35

COUNTY	ROUTE NO.	ROUTE NAME	SHEET NO.
DORCHESTER	SC 165	DELMAR HIGHWAY	16

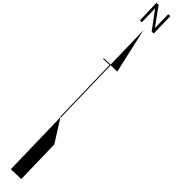

MATCHLINE STA.308+50 SEE SHEET 15

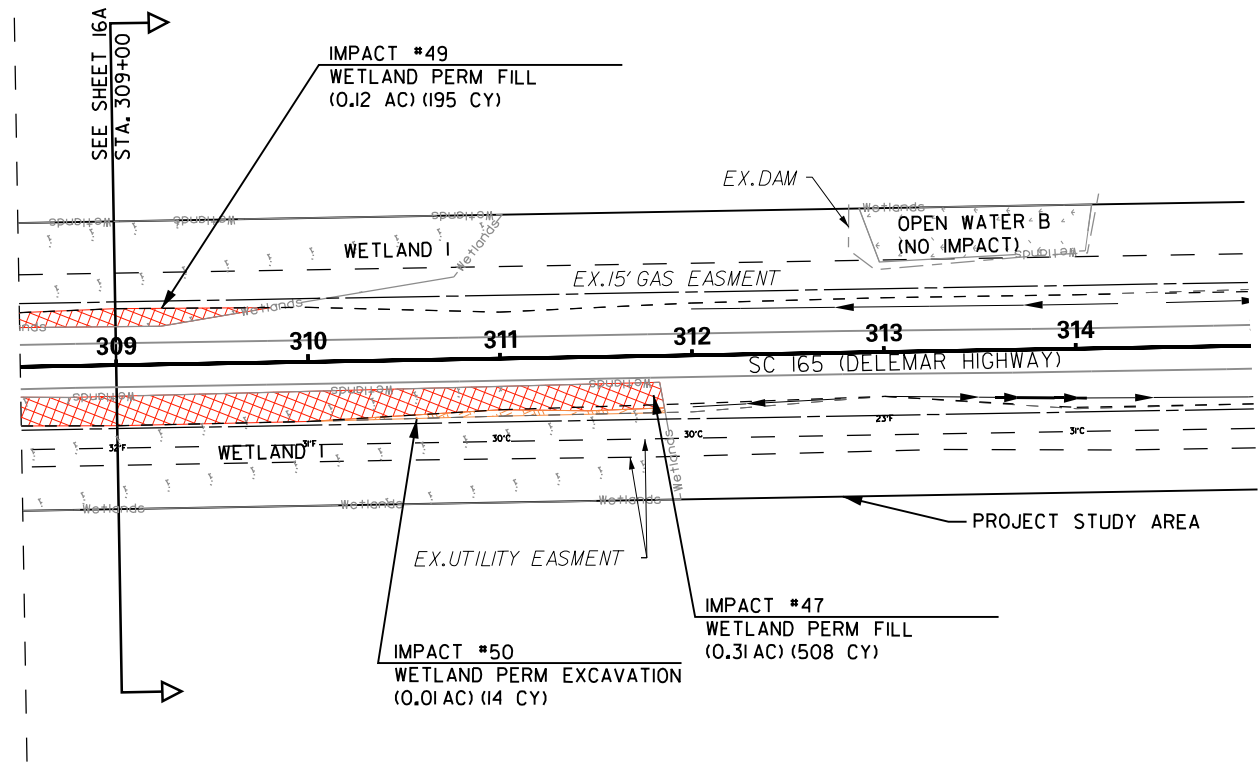

LEGEND	
FILL/CUT LIMIT	----
OPEN WATER	
WETLAND	
RPW STREAM	SP
PERMANENT WETLAND EXCAVATION IMPACT	
PERMANENT WETLAND FILL IMPACT	

PREPARED BY:
Stantec
 Stantec Consulting Services
 4969 Centre Pointe Drive, Suite 200
 North Charleston, SC 29418
 Tel: 843.740.7700
 Fax: 843.740.7707
 www.stantec.com

REV. NO.	BY	DATE	DESCRIPTION OF REVISION
4			
3			
2			
1			

STANTEC PROJECT NUMBER: 171002316
 DATE: 5/17/2022
 SCDOT PIN: _____

SCALE IN FEET

PLANS NOT FOR CONSTRUCTION

APPLICATION BY: **SCDOT**
 SOUTH CAROLINA DEPARTMENT OF TRANSPORTATION

DORCHESTER COUNTY
 SC 165 (DELMAR HIGHWAY)
 IMPACT PLAN VIEW
 404 PERMIT DRAWINGS

SCALE: 1" = 100' SHEET 32 OF 35

COUNTY	ROUTE NO.	ROUTE NAME	SHEET NO.
DORCHESTER	SC 165	DELMAR HIGHWAY	16A

SC 165 (DELMAR HIGHWAY)

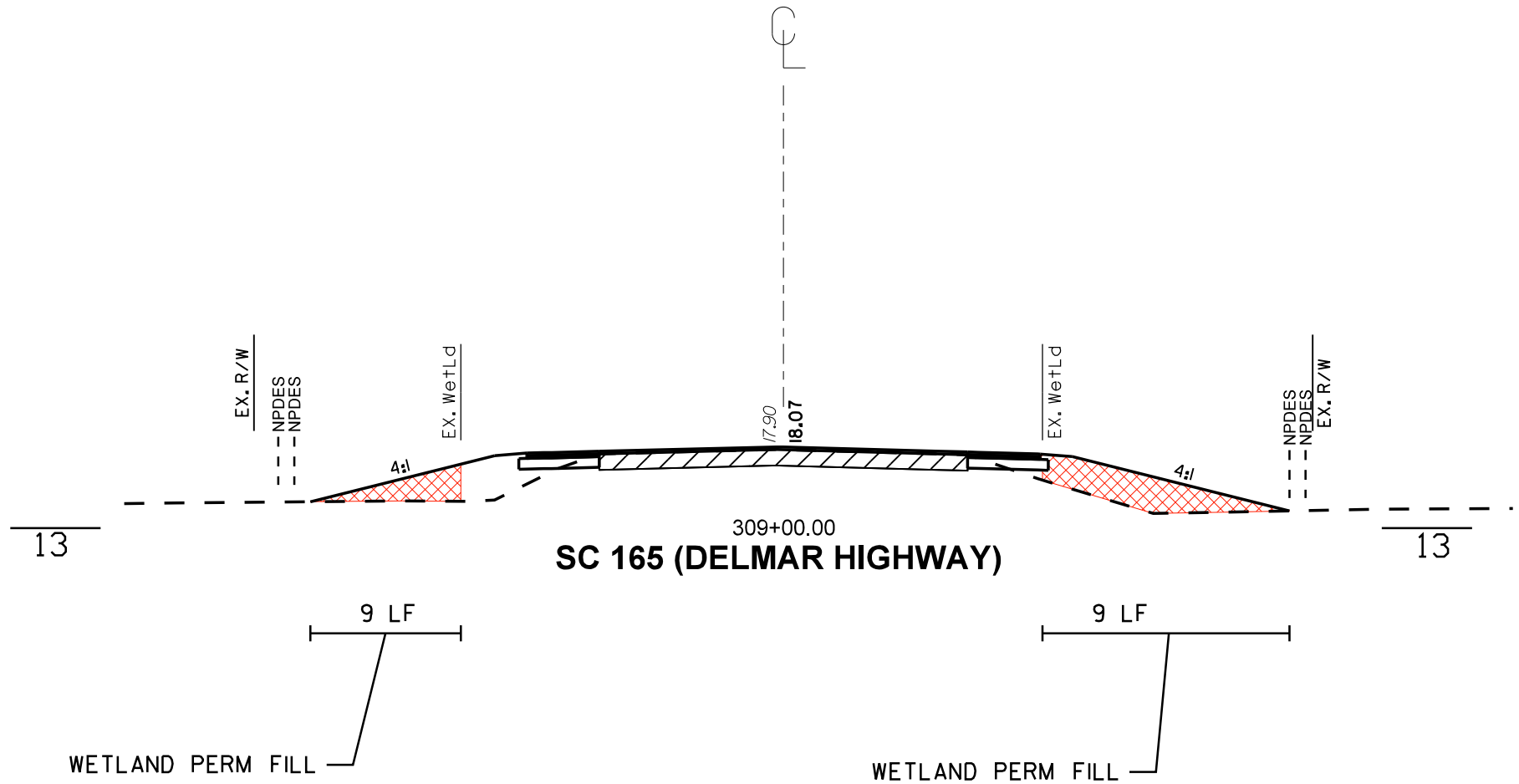

WETLAND PERMANENT FILL IMPACT



WETLAND PERMANENT EXCAVATION IMPACT

PREPARED BY:



Stantec Consulting Services
 4969 Centre Pointe Drive, Suite 200
 North Charleston, SC 29418
 Tel: 843.740.7700
 Fax: 843.740.7707
 www.stantec.com

4			
3			
2			
1			
REV. NO.	BY	DATE	DESCRIPTION OF REVISION
STANTEC PROJECT NUMBER: 171002316			
DATE: 05/17/2022			
SCDOT PIN: _____			

APPLICATION BY: **SCDOT**
 SOUTH CAROLINA DEPARTMENT OF TRANSPORTATION

DORCHESTER COUNTY
 SC 165 (DELMAR HIGHWAY)
 PROJECT ID P038365
 404 PERMIT DRAWINGS

SCALE: N.T.S. SHEET 33 OF 35

COUNTY	ROUTE NO.	ROUTE NAME	SHEET NO.
DORCHESTER	SC 165	DELMAR HIGHWAY	17

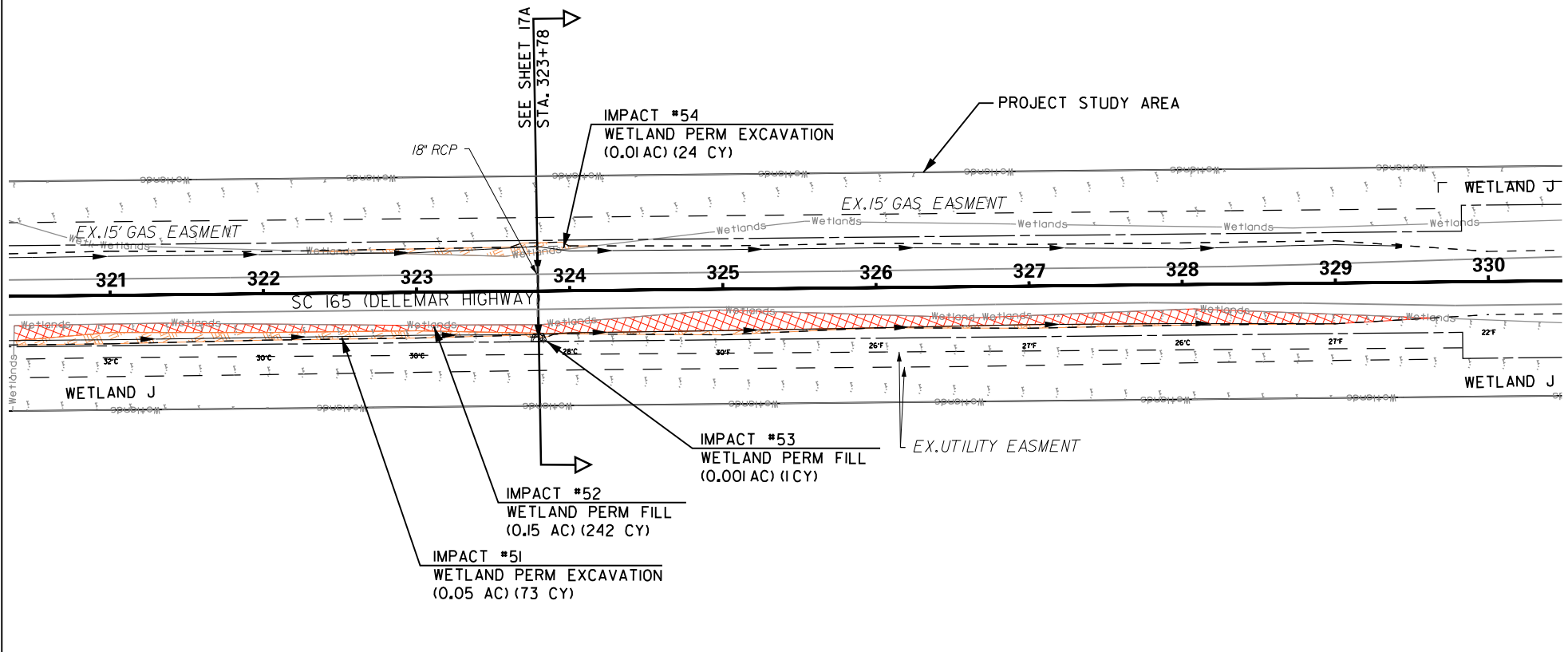

LEGEND	
FILL/CUT LIMIT	----
OPEN WATER	
WETLAND	
RPW STREAM	SP
PERMANENT WETLAND EXCAVATION IMPACT	
PERMANENT WETLAND FILL IMPACT	

PREPARED BY:
Stantec
 Stantec Consulting Services
 4969 Centre Pointe Drive, Suite 200
 North Charleston, SC 29418
 Tel: 843.740.7700
 Fax: 843.740.7707
 www.stantec.com

REV. NO.	BY	DATE	DESCRIPTION OF REVISION
4			
3			
2			
1			

STANTEC PROJECT NUMBER: 171002316
 DATE: 5/17/2022
 SCDOT PIN: _____

SCALE IN FEET
 0 50 100

PLANS NOT FOR CONSTRUCTION

APPLICATION BY: **SCDOT**
 SOUTH CAROLINA DEPARTMENT OF TRANSPORTATION

DORCHESTER COUNTY
 SC 165 (DELMAR HIGHWAY)
 IMPACT PLAN VIEW
 404 PERMIT DRAWINGS

SCALE: 1" = 100'
 SHEET 34 OF 35

COUNTY	ROUTE NO.	ROUTE NAME	SHEET NO.
DORCHESTER	SC 165	DELMAR HIGHWAY	17A

SC 165 (DELMAR HIGHWAY) STA. 323+79.35

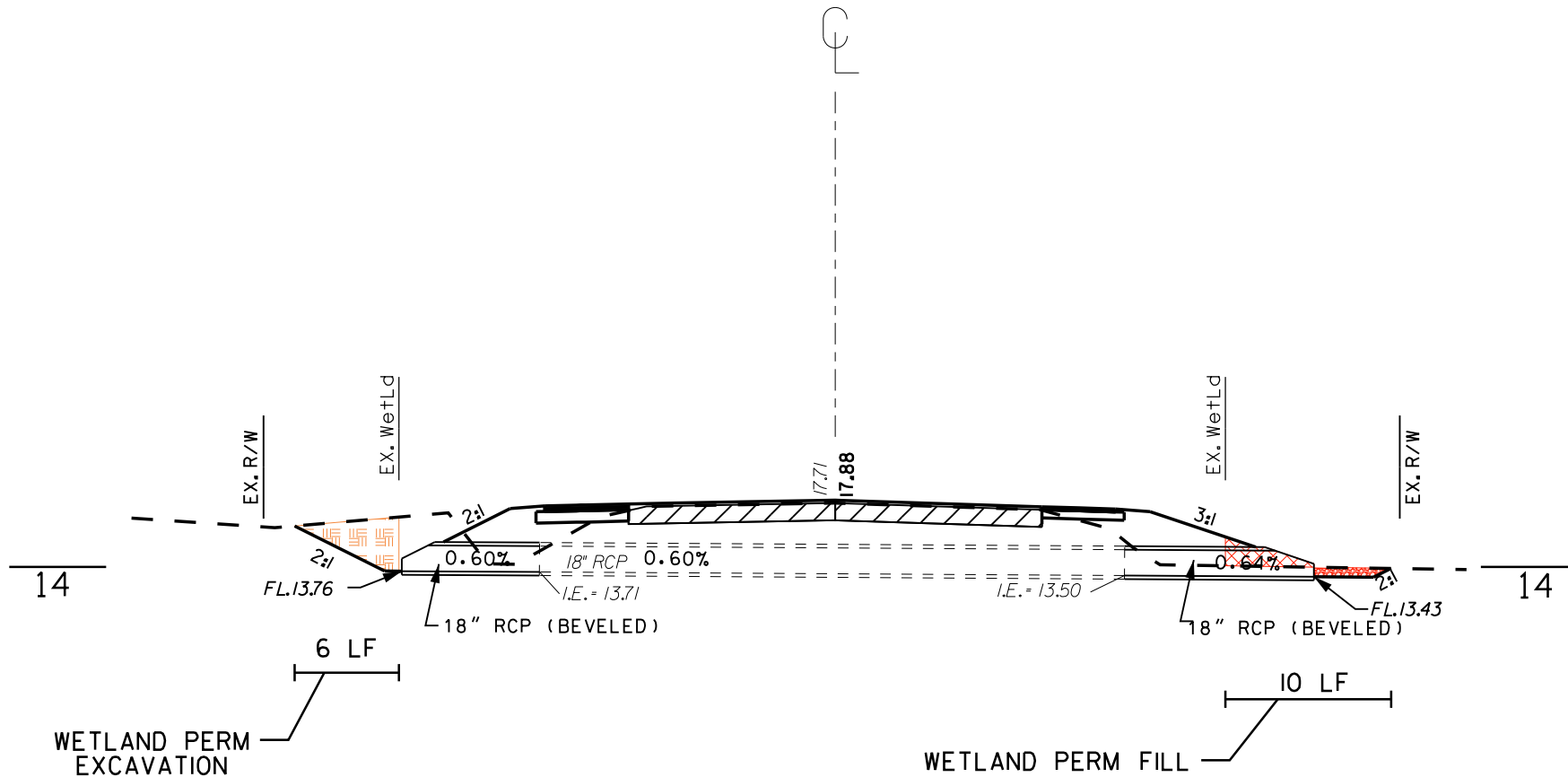

WETLAND PERMANENT FILL IMPACT



WETLAND PERMANENT EXCAVATION IMPACT

PREPARED BY:



Stantec Consulting Services
4969 Centre Pointe Drive, Suite 200
North Charleston, SC 29418
Tel: 843.740.7700
Fax: 843.740.7707
www.stantec.com

4			
3			
2			
1			
REV. NO.	BY	DATE	DESCRIPTION OF REVISION
STANTEC PROJECT NUMBER: 171002316			
DATE: 05/17/2022			
SCDOT PIN: _____			

APPLICATION BY: **SCDOT**
SOUTH CAROLINA DEPARTMENT OF TRANSPORTATION

DORCHESTER COUNTY
SC 165 (DELMAR HIGHWAY)
PROJECT ID P038365
404 PERMIT DRAWINGS

SCALE: N.T.S. SHEET 35 OF 35